



APPENDIX J-2

2011 WILDLIFE BASELINE



RAINY RIVER

**RAINY RIVER GOLD PROJECT
2011 WILDLIFE BASELINE STUDY**

Submitted by:

**AMEC Environment & Infrastructure
a division of AMEC Americas Limited
160 Traders Blvd., Suite 110
Mississauga, Ontario
L4Z 3K7**

**June 2012
TC111504**





June 28, 2012
TC111504

Mr. Kyle Stanfield, P.Eng
Vice President, Environment & Sustainability
Rainy River Resources Ltd.
1111 Victoria Avenue East
Thunder Bay, ON
P7C 1B7

Dear Mr. Stanfield,

AMEC Environment & Infrastructure is pleased to submit the attached 2011 Terrestrial Wildlife Baseline Study for the Rainy River Gold Project.

The 2011 Terrestrial Wildlife Baseline Study adds a second year of bird and amphibian surveys to the 2010 Baseline Study conducted by Klohn Crippen Berger and fills in gaps in survey locations within the Local Study Area.

We greatly appreciate the opportunity to provide support for your Rainy River Gold Project. Should you have any questions regarding the study, please do not hesitate to contact us.

Yours Sincerely,

AMEC Environment & Infrastructure,
a division of AMEC Americas Limited

A handwritten signature in grey ink that reads "Sheila Daniel". The signature is fluid and cursive.

Sheila Daniel, M.Sc. P.Geo.
Senior Associate Geoscientist
Head, Environmental Management

AMEC Environment & Infrastructure,
a division of AMEC Americas Limited
160 Traders Blvd. East, Suite 110
Mississauga, Ontario, Canada L4Z 3K7
Tel (905) 568-2929
Fax (905) 568-1686

www.amec.com

TABLE OF CONTENTS

	<u>Page</u>
1.0 INTRODUCTION.....	1
2.0 STUDY OBJECTIVES	1
3.0 METHODOLOGY.....	1
3.1 Bird Surveys	1
3.1.1 Breeding Bird Surveys	1
3.1.2 Marsh Bird Surveys.....	2
3.1.3 Nocturnal Bird Surveys	2
3.1.4 Short-eared Owl Surveys.....	3
3.1.5 Avian Species at Risk Surveys	3
3.2 Amphibian Surveys	3
3.3 Other Taxa	4
4.0 RESULTS	4
4.1 Avian Community	4
4.1.1 Forest Bird Species.....	6
4.1.2 Open Field Bird Species	7
4.1.3 Wetland Bird Species.....	8
4.2 Amphibian Community	9
4.3 Mammalian Community (Incidental Observations).....	10
4.4 Invertebrates (Incidental Observations).....	10
5.0 CONCLUSIONS.....	10
6.0 REFERENCES.....	11

LIST OF APPENDICES

- A Compiled Wildlife Species List
- B Amphibian Monitoring Data Sheets



LIST OF FIGURES

	<u>Page</u>
Figure 1: Project Location	13
Figure 2: Survey Stations.....	14
Figure 3: Mammal Observations.....	15

LIST OF TABLES

Table 1: Call Level Codes used to describe Calling Amphibian Species.....	4
Table 2: Most Common Bird Species Talled during 2011 Breeding Bird Point Counts.....	5
Table 3: Frequency of Occurrence and Abundance Rank of Amphibian Species	9

1.0 INTRODUCTION

AMEC Environment & Infrastructure, a division of AMEC Americas Limited (AMEC), was retained by Rainy River Resources (RRR) Ltd. to conduct avian and amphibian surveys at the Rainy River Gold Project site in the Township of Chapple, approximately 65 kilometres (km) northwest of Fort Frances in northwest Ontario (Figure 1). A baseline wildlife survey was conducted for the area surrounding the exploration site by Klohn Crippen Berger (KCB) in 2010 (KCB 2011). The 2011 surveys undertaken by AMEC were designed to expand on the wildlife database developed by KCB, to provide extended geographic and temporal coverage of the Project site area. This report provides the summary of these surveys, as well as other incidental wildlife observations (i.e., mammals), conducted in May and June, 2011. Additional wildlife studies are also being undertaken by AMEC in 2012, to provide further geographical coverage in response to the developing Rainy River Gold Project site plan, which was not fully developed at the time of the earlier studies. The 2012 survey results will be reported separately.

2.0 STUDY OBJECTIVES

The primary objectives of the 2011 Terrestrial Baseline Study were to add a second year of bird and amphibian surveys to the 2010 Baseline Study conducted by KCB (2011), and to fill in gaps in survey locations within the local study area (LSA). A second year of bird and amphibian surveys was deemed desirable in order to provide a higher degree of confidence in the final list of species present within the LSA and their respective distribution and abundance.

3.0 METHODOLOGY

In their 2010 Baseline Report, KCB (2011) described the LSA as a circle with a 5 km diameter, centered on the Advanced Exploration Project Facility. For the purpose of this study, the LSA will refer to the lands bounded by Highway 71 to the east, and Dearlock to the west. This encompasses all of the 2011 monitoring stations that AMEC sampled for this report (Figure 2).

3.1 Bird Surveys

The following wildlife surveys were conducted in May and June of 2011 and were designed to sample wildlife species diversity (primarily birds and amphibians) within the LSA during their respective breeding seasons.

3.1.1 Breeding Bird Surveys

The 2011 breeding bird surveys were conducted on May 25, 26, 27, and on June 15, 16, and 17. Surveys were conducted in accordance with the protocol described in the Atlas of the

Breeding Birds of Ontario (Cadman et al. 2007). Surveys were mostly conducted along roadsides at intervals of at least 800 m. A total of 29 breeding bird stations were surveyed, covering much of the LSA (Figure 2). The locations of the survey stations mirrored those used in the 2010 Baseline Report (KCB 2011) in order to provide inter-year information, as well as some new locations to fill in gaps in coverage. At each station, all birds seen or heard within a 10 minute period were recorded on a datasheet. Surveys were conducted in the morning and began one half hour prior to sunrise (dawn) and ended before 10:00 am.

Weather conditions during the breeding bird surveys were sunny to overcast, with winds between 0 (Calm) and 3 (Gentle Breeze) on the Beaufort scale. Temperatures during the surveys ranged between 5 to 17°C. Surveys were not conducted during in the rain.

3.1.2 Marsh Bird Surveys

Though marsh bird monitoring was not a formal part of the studies conducted, marsh birds were recorded opportunistically during nocturnal owl and amphibian surveys, which took place at night, during the same time frame as standard marsh bird monitoring, and many survey points were located near to habitats suitable for marsh birds. Contrary to methods used for the Marsh Monitoring Program (Bird Studies Canada 2009a), call playback tapes were not used, yet all marsh species seen or heard calling were recorded.

3.1.3 Nocturnal Bird Surveys

The 2011 nocturnal bird surveys were conducted on May 24 and 25, and on June 15 and 16, using the Northern Ontario Nocturnal Owl Protocol described in Takats et al. (2001) as a guideline. Eleven stations were surveyed within the LSA at 1.6 km intervals along roadsides (Figure 2). The locations of the survey stations mirrored those used in the 2010 Baseline Report (KCB 2011) in order to provide inter-year information, as well as some new locations to fill in gaps in coverage.

Calls of the six nocturnal owl species previously recorded in the study area (Northern Saw-whet Owl (*Aegolius acadicus*), Boreal Owl (*Aegolius funereus*), Long-eared Owl (*Asio otus*), Barred Owl (*Strix varia*), Great Grey Owl (*Strix nebulosa*), and Great Horned Owl (*Bubo virginianus*)) were played using portable speakers. Calls of each species were played for 20 seconds, followed by a one minute listening period. The survey at each station began with a two-minute listening period. Species calls were played in order of the size of the owl species beginning with the smallest species and ending with the largest species. All owl observations were recorded on a datasheet. Surveys began one-half hour after sunset and concluded at midnight.

3.1.4 Short-eared Owl Surveys

Separate Short-eared Owl surveys were conducted, because this species is active at dusk and occupies more open habitat compared with the other owl species. An extensive roadside Short-eared Owl (*Asio flammeus*) survey was conducted in June. A route was driven which passed through all suitable Short-eared Owl habitat (grassland, pasture and meadow-marsh) within the LSA. Ten minute surveys were conducted in all suitable habitat areas where each area was scanned with binoculars by observers familiar with Short-eared Owl habitat and behaviour. Fields were scanned for foraging owls and fence-posts and trees along the edges were scanned for perched owls. This survey began one hour prior to sunset and ended one-half hour after sunset.

3.1.5 Avian Species at Risk Surveys

Surveys were conducted for provincially and federally listed avian Species at Risk (SAR). The results are presented and discussed in a separate report (AMEC 2011).

3.2 Amphibian Surveys

Survey methods followed the Marsh Monitoring Program Amphibians Survey (Bird Studies Canada 2009b) which were conducted on May 24, 25, 26, and on June 15, 16, and 17, 2011. Two rounds of point count call surveys were conducted in order to ensure that early and late-breeding frog species were detected. A total of 20 amphibian point count stations were surveyed once during each round of surveys (Figure 2). The locations of the survey stations mirrored those used in the 2010 Baseline Report (KCB 2011) in order to provide inter-year information, as well as some new locations to fill in gaps in coverage.

Amphibian surveys were conducted May 24 to 26, 2011, and June 15 to 17, 2011. Two rounds of monitoring ensured early and late-breeding frog species were detected. A total of 20 amphibian stations were surveyed once during each round of surveys (Figure 2). Survey points mirrored those used in the 2010 Baseline Report (KCB 2011).

Calling species were recorded during a three minute period with a recording radius of unlimited distance. The calls of each amphibian species were assigned specific 'call level codes' according to call levels found in the Marsh Monitoring Program Amphibians Survey (Bird Studies Canada 2009b; see Table 1). Studies were conducted at night and began one half hour after sunset (twilight) and were concluded before midnight.

Table 1: Call Level Codes used to describe Calling Amphibian Species

Call Level Code	Description
0	None heard
1	Individuals can be counted, calls not overlapping
2	Numbers of some individuals can be estimated or counted
3	Full chorus, calls continuous and overlapping, individuals not distinguishable

Source: Bird Studies Canada 2009b

3.3 Other Taxa

Mammal, reptile and insect species observed within the LSA were recorded opportunistically during all surveys (as were birds and amphibians when observed outside of the formal bird and amphibian surveys). Observations included, but were not limited to, visual observation, hearing calls, road kill, tracks, scat, burrows, and nests.

4.0 RESULTS

4.1 Avian Community

A total of 113 bird species were observed within or adjacent to the LSA in during the late spring and early summer of 2011. The most common species are presented in Table 2 and a complete species list is found in Appendix A. Of the 113 bird species, 106 are suspected to be nesting within the LSA.

The avian species diversity and population densities found within the LSA reflect the area's mosaic of mixed, deciduous-dominated forest, shrubby wetlands, and open field habitats. The species diversity is also influenced by the LSA geographic location within Ontario, occurring within a transition zone from a temperate to a boreal forest ecozone, and near the edge of Canada's prairie region. According to the Ontario Atlas of Breeding Birds (Cadman et al. 2007) the area is located in the Northern Shield Region of Ontario but is known for a unique species composition that is not seen in the eastern or northern parts of the Region.

Nine provincially and/or federally listed avian SAR species (including three *Species of Special Concern* and six *Threatened* species) were observed in the LSA during the 2011 spring and summer surveys. These are presented and discussed in a separate report (AMEC 2011).

Table 2: Most Common Bird Species Tallied during 2011 Breeding Bird Point Counts

Common Name	Mean #	Frequency (%)
White-throated Sparrow	1.62	82.76
Common Yellowthroat	1.59	65.52
Nashville Warbler	1.41	68.97
American Robin	1.34	82.76
Ovenbird	1.31	65.52
Song Sparrow	1.10	72.41
Clay-colored Sparrow	1.07	48.28
Savannah Sparrow	1.07	51.72
European Starling	0.97	17.24
Canada Goose	0.90	27.59
Veery	0.86	62.07
Yellow Warbler	0.83	44.83
Common Raven	0.76	44.83
Bobolink	0.72	41.38
Chestnut-sided Warbler	0.66	44.83
Red-winged Blackbird	0.66	34.48
Sandhill Crane	0.66	48.28
Red-eyed Vireo	0.62	41.38
Least Flycatcher	0.59	37.93
Wilson's Snipe	0.59	44.83
American Crow	0.55	27.59
American Goldfinch	0.55	51.72
Cedar Waxwing	0.55	17.24
Swamp Sparrow	0.55	24.14
Alder Flycatcher	0.52	37.93
Blue Jay	0.52	44.83
Rose-breasted Grosbeak	0.52	37.93
Chipping Sparrow	0.48	41.38
American White Pelican	0.45	6.90
Black-and-white Warbler	0.41	31.03
Ruffed Grouse	0.41	41.38
Brown-headed Cowbird	0.38	31.03
Hermit Thrush	0.38	27.59
Mourning Warbler	0.38	31.03
Northern Flicker	0.38	37.93
Yellow-rumped Warbler	0.38	27.59
Black-billed Magpie	0.34	27.59
Black-capped Chickadee	0.24	17.24
Great Blue Heron	0.24	17.24
House Wren	0.24	17.24
Sedge Wren	0.24	17.24
Golden-winged Warbler	0.21	13.79
Gray Catbird	0.17	17.24
American Kestrel	0.14	10.34
American Redstart	0.14	13.79

Common Name	Mean #	Frequency (%)
Barn Swallow	0.14	10.34
Mallard	0.14	6.90
Red-breasted Nuthatch	0.14	13.79
Wilson's Warbler	0.14	10.34
Eastern Kingbird	0.10	10.34
Great Crested Flycatcher	0.10	10.34
Killdeer	0.10	10.34
Leconte's Sparrow	0.10	10.34
Tree Swallow	0.10	3.45
Woodpecker sp	0.10	10.34
American Bittern	0.07	6.90
Blackburnian Warbler	0.07	6.90
Brewer's Blackbird	0.07	6.90
Conneticut Warbler	0.07	6.90
Eastern Phoebe	0.07	6.90
Golden-crowned Kinglet	0.07	6.90
Gray Jay	0.07	6.90
Magnolia Warbler	0.07	6.90
Philadelphia Vireo	0.07	6.90
Ruby-crowned Kinglet	0.07	3.45
Tennessee Warbler	0.07	6.90
Winter Wren	0.07	6.90
Yellow-bellied Sapsucker	0.07	6.90
Bald Eagle	0.03	3.45
Baltimore Oriole	0.03	3.45
Black-throated Green Warbler	0.03	3.45
Brown Thrasher	0.03	3.45
Common Grackle	0.03	3.45
Eastern Bluebird	0.03	3.45
Eastern Wood-Pewee	0.03	3.45
Northern Harrier	0.03	3.45
Northern Parula	0.03	3.45
Olive-sided Flycatcher	0.03	3.45
Palm Warbler	0.03	3.45
Ruby-throated Hummingbird	0.03	3.45
Swainson's Thrush	0.03	3.45
Turkey Vulture	0.03	3.45

Notes: Mean # - Average number of birds observed per station
 Frequency (%) - Percent of stations where the species was observed

4.1.1 Forest Bird Species

Approximately half of the LSA is covered by poplar dominated forest (KCB 2011) and thus supported a wide variety of forest-dwelling species. Twenty-six Area-Sensitive species of birds were recorded in the 2011 surveys and 20 of these were forest-dwelling species. Among the most numerous forest-dwelling bird species recorded during breeding bird counts were species

such as the White-throated Sparrow (*Zonotrichia albicollis*), Nashville Warbler (*Oreothlypis ruficapilla*), Ovenbird (*Seiurus aurocapilla*), Veery (*Catharus fuscescens*), and Red-eyed Vireo (*Vireo olivaceus*). Small areas of coniferous forest and bog were present within the LSA which supported boreal species such as the Palm Warbler (*Dendroica palmarum*) Connecticut Warbler (*Oporonis agilis*), Gray Jay (*Perisoreus canadensis*), and LeConte's Sparrow (*Ammodramus leconteii*). These results are consistent with the most frequently observed forest birds reported by KCB (2011).

Most forest-breeding species observed have extensive Canadian breeding ranges that extend from eastern Canada, across the boreal zone, and into western Canada. The Eastern Woodpecker (*Contopus virens*) was an observed forest-dwelling species occurring at the northern edge of its North American range.

Five species of forest-dwelling owls were recorded: two Northern Saw-whet Owls, two Barred Owls, a Great Horned Owl, Long-eared Owl, and a Barred Owl. No Short-eared Owls were observed during the Short-eared Owl survey.

4.1.2 Open Field Bird Species

Pasture and agricultural lands cover approximately 17% of the LSA (KCB 2011), thus it is unsurprising that grassland bird species are among the most common species recorded in the LSA. Savannah Sparrow (*Passerculus sandwichensis*), Clay-coloured Sparrow (*Spizella pallida*), Bobolink and, Sandhill Crane (*Grus canadensis*) are open county species that were among those most commonly observed during the breeding bird surveys.

Open country species at the northern edge of their North American range included Northern Rough-winged Swallow (*Stelgidopteryx serripennis*), Golden-winged Warbler (*Vermivora chrysoptera*) and Brown Thrasher (*Toxostoma rufum*).

Black-billed Magpie (*Pica pica*), Brewer's Blackbird (*Euphagus cyanocephalus*) and Prairie Sharp-tailed Grouse (*Tympanuchus phasianellus campestris*) are prairie species whose Ontario population is concentrated wholly or in part in the Rainy River area. The Black-billed Magpie's breeding range in Ontario is restricted to the districts of Kenora and Rainy River. This species was commonly observed in agricultural lands close to anthropogenic features. The Prairie subspecies of the Sharp-tailed Grouse exists as two disjunct populations in Ontario: one Rainy River population and one population along the North Shore of Lake Huron. The *T. p. campestris* subspecies originated in the prairies and only occupies open plain and farmland habitats, and occupies different ecological and geographical niches than the Northern subspecies, *T. p. phasianellus* (Cadman et al. 2007). One road-killed *T. p. campestris* was observed in the LSA. Similar to *T. p. campestris*, the Brewer's Blackbird also occupies only two population centres in Ontario, one of which occurs in the Rainy River area and the other along the north shore of Lake Huron extending south into the Bruce Peninsula.

One American Golden Plover (*Pluvialis dominica*) was observed in a pasture at the northern end of Gallinger Road. The individual observed is likely a late migrant as this species is a sparse Ontario breeder, restricted to tundra habitat along Hudson Bay and James Bay.

Four species of swallows were observed in the LSA. A colony of Barn Swallows (*Hirundo rustica*) and Cliff Swallows (*Petrochelidon pyrrhonota*) was observed on the farm property south of the intersection of Teeple Road and Heatwole Road. Adult swallows of each species were observed flying in and out of the barn and shed on the property. Northern Rough-winged Swallows were also observed at the same location but rather than nesting in barns and sheds, this species nests in burrows dug into sandy banks. These burrows are typically excavated and later abandoned by Bank Swallows. No Bank Swallows were observed in the LSA during the 2011 investigations. Tree Swallows (*Tachycineta bicolor*) were recorded throughout the study area and are cavity nesters that commonly nest in abandoned woodpecker holes, especially in poplar trees which were abundant in the LSA.

4.1.3 Wetland Bird Species

Wetlands cover approximately 25% of the LSA (KCB 2011) and include riparian wetlands, meadow marsh, treed and open fen, and bog. The most common wetland species recorded included Common Yellowthroat (*Geothlypis trichas*), Yellow Warbler (*Dendroica petechia*), Swamp Sparrow (*Melospiza Georgiana*) and Wilson's Snipe (*Gallinago delicate*). These species are common residents of riparian wetlands which bordered a great proportion of both woodlands and open country within the study area and were thus well represented during breeding bird surveys.

Observed colony-nesting swamp species included Great Blue Heron (*Ardea herodias*) and Green Heron (*Butorides virescens*), though no heronries were found in the LSA. Open water breeding species including American White Pelican (*Pelecanus erythrorhynchos*), Double-crested Cormorant (*Phalacrocorax auritus*), and Ring-billed Gull (*Larus delawarensis*) were also observed. These species are wide-ranging in their search of food and will use the area for foraging. Colonies of these species are known to occur on Lake of the Woods, Rainy Lake, Kakagi Lake and other large lakes in the Rainy River District, yet no suitable breeding habitat occurs within the LSA.

Waterfowl were not readily observed in the study area, though five species were recorded which included Trumpeter Swan (*Cygnus buccinator*), Canada Goose (*Branta canadensis*), Mallard (*Anas platyrhynchos*), Wood Duck (*Aix sponsa*) and Hooded Merganser (*Lophodytes cucullatus*). All five species nest in swamps or wooded ponds, which are common in the study area. Canada Geese were most often observed near ponds in agricultural fields or pasture. Wood Ducks and Hooded Mergansers nest in tree cavities. Two Trumpeter Swans were observed flying north-eastward at dusk during an amphibian survey. The breeding bird atlas

indicates that a small Trumpeter Swan breeding population exists in the Rainy River area and it is one of only four breeding populations in Ontario for this species.

Marsh bird species observed included American Bittern (*Botaurus lentiginosis*) and Sora (*Porzana carolina*). American Bittern was commonly encountered within the LSA and was recorded during breeding bird, nocturnal bird, and amphibian surveys. Two Soras were heard calling near Marr Creek, north of Highway 600.

4.2 Amphibian Community

Seven amphibian species were recorded within the LSA (Appendix A; raw data are provided in Appendix B). Early spring-breeding frog species observed included Boreal Chorus Frog (*Pseudacris maculata*), Spring Peeper (*Pseudacris crucifer*), Wood Frog (*Rana sylvatica*) and Northern Leopard Frog (*Rana pipiens*). Frog species observed that are late spring-breeders included American Toad (*Bufo americanus*) and Tetraploid Gray Treefrog (*Hyla versicolor*). Mink Frog (*Rana septentrionalis*) was the only summer-breeding species observed. No salamander species were observed.

The Tetraploid Gray Treefrog was the most common frog species observed during the summer amphibian surveys, as well as the most common frog species observed across the study area. The Spring Peeper was the early spring breeding frog species most commonly observed (Table 3).

Table 3: Frequency of Occurrence and Abundance Rank of Amphibian Species*

Species	Abundance Rank	Frequency (%)
Tetraploid Gray Treefrog	1	90
Spring Peeper	2	40
Wood Frog	3	30
American Toad	4	30
Boreal Chorus Frog	5	15
Northern Leopard Frog	6	10
Mink Frog	7	5

Notes: Mean # - Average number of birds observed per station

Frequency (%) – Percent of stations where the species was observed

* Recorded from 20 Amphibian Monitoring Stations during the Spring and Summer

Frequencies of early spring breeding species may have been under-detected due to the cold evening temperatures observed during the May 24 to 27, 2011 site visit. Mink Frogs were only recorded during one formal amphibian surveys yet were heard and visually observed at other locations during the daytime.

4.3 Mammalian Community (Incidental Observations)

A total of eight mammalian species were recorded within the LSA (listed in Appendix A). White-tailed Deer (*Odocoileus virginianus*) were commonly observed throughout the LSA as were their tracks and droppings, indicating a high level of local habitat use by this species. Three Black Bear (*Ursus americana*) observations were made and are shown in Figure 3. Evidence of Beaver (*Castor canadensis*) activity such as dams, lodges, and chewed stumps were recorded along some streams (Figure 3) though no individual animals were visually observed.

4.4 Invertebrates (Incidental Observations)

Four species of dragonflies were recorded in the LSA. These included Kennedy's Emerald (*Somatochlora kennedyi*), Hudsonian Whiteface (*Leucorrhinia glacialis*), Four-spotted Skimmer (*Libellula quadrimaculata*), and a Baskettail (*Epitheca*) species. Canadian Tiger Swallowtail (*Papilio canadensis*), Mourning Cloak (*Nymphalis antiopa*), and a Duskywing (*Erynnis*) species were the only three butterfly species recorded.

5.0 CONCLUSIONS

The primary objectives of this 2011 Terrestrial Baseline Study were to add a second year of bird and amphibian surveys to the 2010 Baseline Study conducted by KCB (2011) in order to provide increased geographic and temporal coverage of the Project site area, and to provide a higher degree of confidence in the list of species present within the LSA and their respective distribution and abundance. Wildlife surveys were conducted in May and June of 2011 and were designed to sample bird and amphibian species diversity, distributions, and abundances within the LSA during their respective breeding seasons. Mammal, reptile and insect species were also recorded opportunistically during all surveys.

A total of 113 bird species were observed within or adjacent to the LSA in the early summer (May and June) of 2011. Of these 113 bird species, 106 are suspected to be nesting within the study area. This relatively high level of avian species diversity reflects the LSA's mosaic of mixed, deciduous-dominated forest, shrubby wetlands, and open field habitats. The species diversity is also influenced by the LSA's geographic location within Ontario, occurring within a transition zone from a temperate to a boreal forest ecozone, and near the edge of Canada's prairie region. According to the Ontario Atlas of Breeding Birds (Cadman et al. 2007) the area is located in the Northern Shield Region of Ontario but is known for a unique species composition that is not seen in the eastern or northern parts of the Region.

Of the 113 bird species observed within the LSA, nine are provincially and/or federally listed SAR species (including three *Species of Special Concern*, and six *Threatened* species). These are presented and discussed in a separate report (AMEC 2011).

The vast majority of the species observed in the LSA are migratory species and therefore, compliance with the *Migratory Birds Convention Act* (MBCA 1994), regulations and guidelines for vegetation clearing, as recommended by Environment Canada, needs to be considered during the project's construction and operation phases. In order to minimize the potential for incidental take of any nesting migratory birds, clearing of vegetation and any proposed work activities in migratory bird habitat should be undertaken outside of the active breeding season. Clearing is generally to be avoided from mid-May to August 1. If clearing (or other work) in migratory bird habitat is required during the nesting season, a nest survey should be conducted by a qualified avian biologist immediately (i.e., within 2 days) prior to commencement of the works to identify and locate active nests of species covered by the MBCA. An adaptive mitigation plan (which may include establishing appropriate buffers around active nests) should then be developed to address any potential impacts on migratory birds or their active nests, and should be reviewed by Environment Canada prior to implementation.

Seven amphibian species were recorded within the LSA and none of these are considered SAR. Early spring-breeding frog species observed included Boreal Chorus Frog, Spring Peeper, Wood Frog and Northern Leopard Frog. Frog species observed that are late spring-breeders included American Toad and Tetraploid Gray Treefrog. Mink Frog was the only summer-breeding species observed. No salamander species were observed.

A total of eight mammalian species were recorded within the LSA (listed in Appendix A). White-tailed Deer were commonly observed throughout the LSA as were their tracks and droppings, indicating a high level of local habitat use by this species. Three Black Bear observations were made and evidence of Beaver activity such as dams, lodges, and chewed stumps were recorded along some streams though no individual animals were visually observed.

Four species of dragonflies were recorded in the LSA. These included Kennedy's Emerald, Hudsonian Whiteface, Four-spotted Skimmer, and a Baskettail species. Canadian Tiger Swallowtail, Mourning Cloak, and a Duskywing species were the only three butterfly species recorded.

6.0 REFERENCES

AMEC. 2012. 2011 Rainy River Gold Project, Species at Risk Report.

Bird Studies Canada. 2009a. Marsh Monitoring Program Participants Handbook for Surveying Marsh Birds. Published by Bird Studies Canada in cooperation with Environment Canada and the U.S. Environmental Protection Agency. 17 pp.



- Bird Studies Canada. 2009b. Marsh Monitoring Program Participants Handbook for Surveying Amphibians. Published by Bird Studies Canada in cooperation with Environment Canada and the U.S. Environmental Protection Agency. 13 pp.
- Cadman, M.D., D.A. Sutherland, G.G. Beck, D. Lepage and A.R. Couturier. 2007. Atlas of the Breeding Birds of Ontario. Bird Studies Canada, Environment Canada, Ontario Field Ornithologists, Ontario Ministry of Natural Resources, Ontario Nature. 728 pp.
- Committee on the Status of Endangered Wildlife in Canada (COSEWIC). 2009. COSEWIC Assessment and Status Report on the Whip-poor-will (*Caprimulgus vociferous*) in Canada. 28 pgs.
- Dechant, J.A., M.L. Sondreal, D.H. Johnson, L.D. Igl, C.M. Goldade, A.L. Zimmerman, and B.R. Euliss. 2003. Effects of Management Practices On Grassland Birds: Bobolink. Northern Prairie Wildlife Research Center, Jamestown, ND. Northern Prairie Wildlife Research Center Online. www.npwrc.usgs.gov/resource/literatr/grasbird/bobo/bobo.htm (Version 12DEC2003).
- Environment Canada. 2011. Species at Risk (SARA) Public Registry. www.speciesatrisk.gc.ca.
- Klohn Crippen Berger. 2011. Rainy River Gold Project Baseline Report 2008-2010.
- Ministry of Natural Resources. 2011a. Species at Risk in Ontario (SARO) List. <http://www.mnr.gov.on.ca/speciesatrisk>.
- Ministry of Natural Resources. 2011b. Natural Heritage Information Centre (NHIC). www.nhic.mnr.gov.on.ca/nhic.cfm.
- Takats, D.L., C.M. Francis, G.L. Holoroyd, J.R. Duncan, K.M. Mazur, R.J. Cannings, W. Harris, and D. Holt. 2001. Guidelines for Nocturnal Owl Monitoring in North America. Beaverhill Bird Observatory and Bird Studies Canada, Edmonton, Alberta. 32 pp.
- Wilson, S.G. 1985. Summer Distribution of Whip-poor-wills in Minnesota. *Loon*, 57:6-8

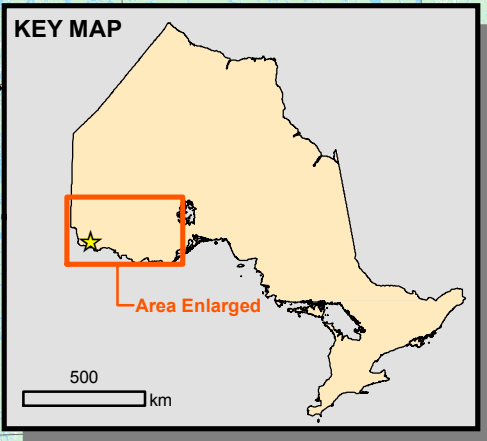
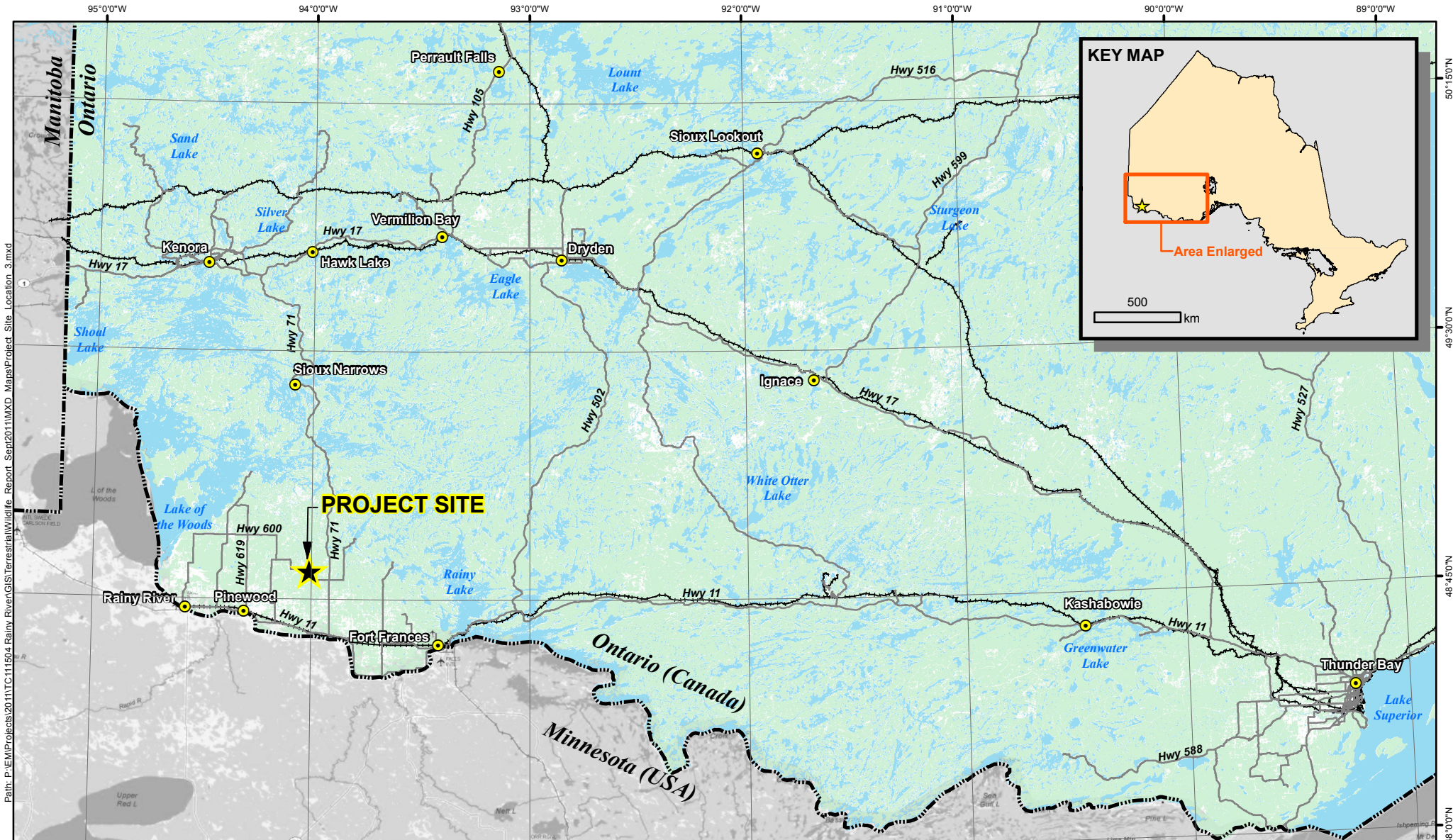

Path: P:\EMIP\Projects\2011\TC111504 Rainy River\GIS\Terrestrial\Wildlife Report_Sep2011\MXD Maps\Project_Site_Location_3.mxd

- LEGEND**
-  Project Site
 -  Regional Communities
 -  Provincial / National Border
 -  Regional Road / Highway
 -  Railway

NOTES:
 - Ontario base data extracted from Land Information Ontario (MNR) data warehouse.
 - Base data outside of Ontario extracted from ESRI DeLorme World Basemap



RAINY RIVER GOLD PROJECT

Project Location



PROJECT N^o: TC111504

FIGURE: 1

SCALE: 1:1,800,000

DATE: June 2012

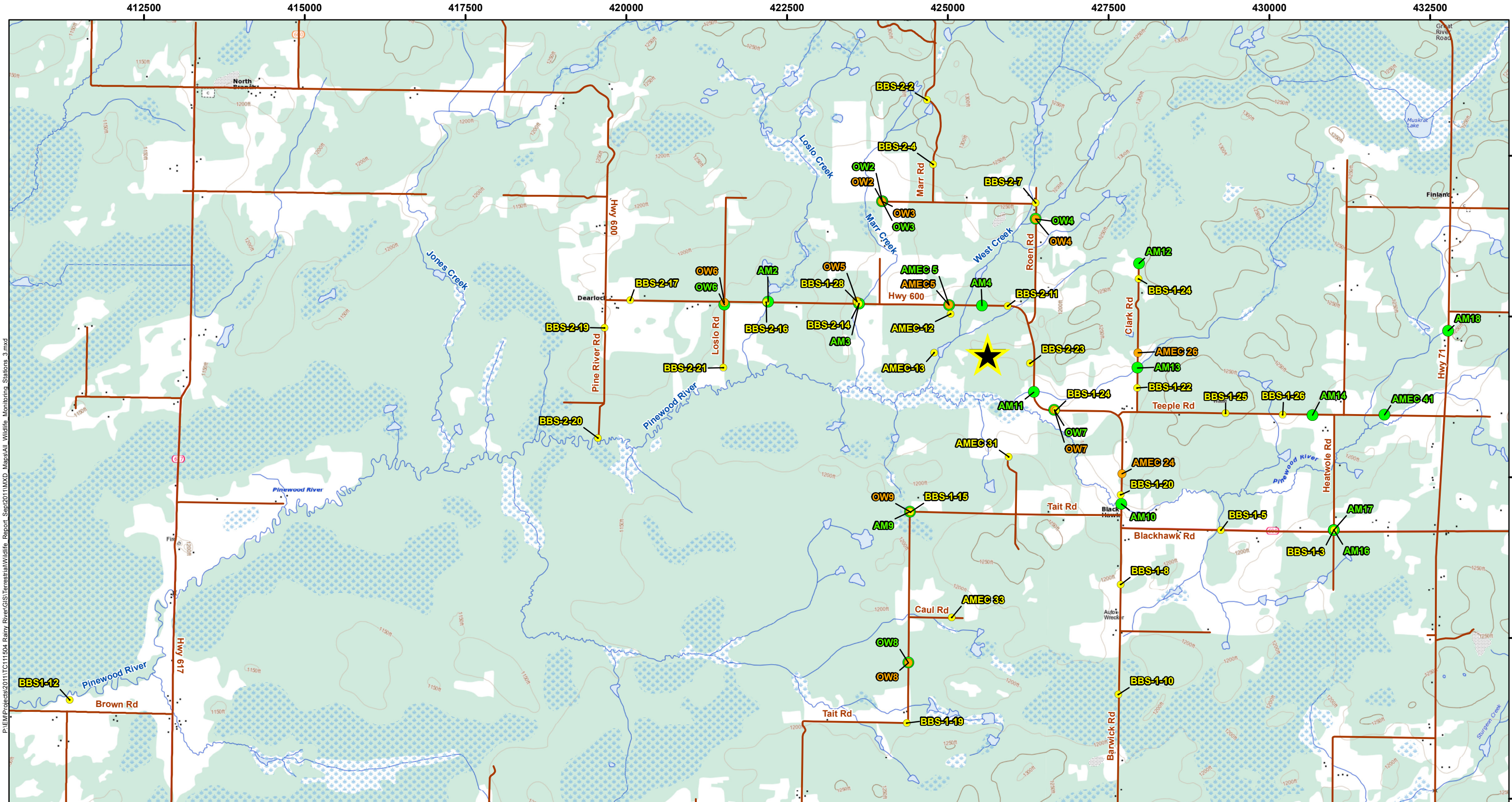

LEGEND

- Project Site
- Roads

Wildlife Monitoring Stations (2011)

- BBS-2-21 Breeding Bird Survey Station
- OW8 Owl Survey Station
- AM9 Amphibian Survey Station

NOTES:
 - Road data extracted from Land Information Ontario, Ontario Road Network, MNR
 - Background topographic map extracted from Toporama, Geogratis, NRCan 1:50k DRG



RAINY RIVER GOLD PROJECT

Location of 2011 Wildlife Survey Stations



Datum: NAD83 Projection: UTM Zone 15N		PROJECT N ^o : TC111504	FIGURE: 2
		SCALE: 1:57,000	DATE: June 2012

P:\EAP\Projects\2011\TC111504_Rainy River\GIS\Terrestrial\Wildlife_Report_Sep2011\MXD_Maps\All_Wildlife_Monitoring_Stations_3.mxd

5412500
5410000
5407500
5405000
5402500

422000

424000

426000

428000

430000

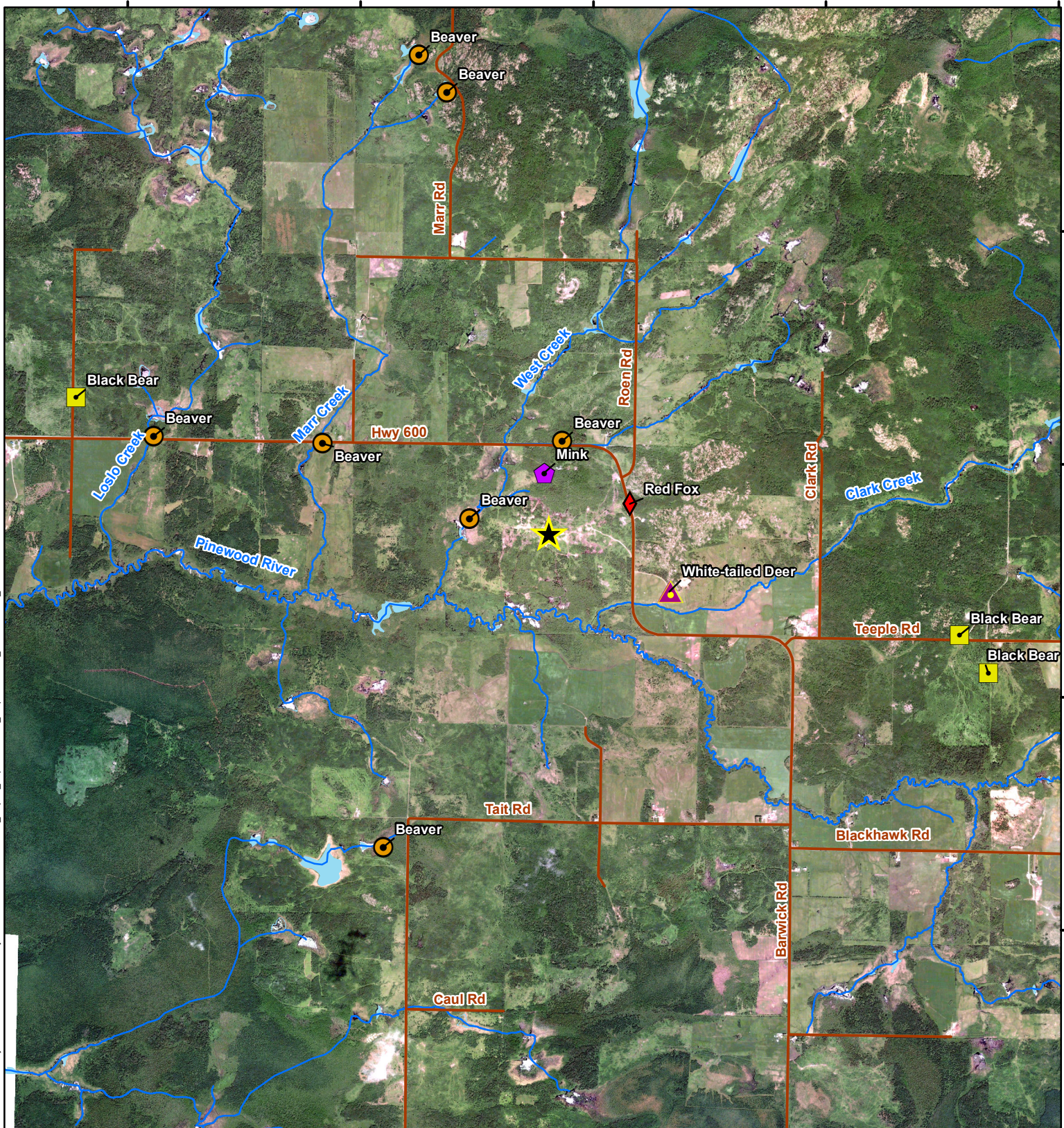

5412000

5410000

5408000

5406000

P:\EM\Projects\2011\TC111504_Rainy River\GIS\Terrestrial\Wildlife_Report_Sept2011\MXD_Maps\Mammal_Observations_2.mxd

LEGEND

Project Site

Roads

Mammal Observations (Labelled on Map)

Beaver

Red Fox

Black Bear

White-tailed Deer

Mink

NOTES:

- Road data extracted from Land Information Ontario, Ontario Road Network, MNR
- Background Imagery extracted from Google Earth Pro



RAINY RIVER GOLD PROJECT

Mammal Observations

Datum: NAD83
Projection: UTM Zone 15N



PROJECT N^o: TC111504

FIGURE: 3

SCALE: 1:45,000

DATE: June 2012





APPENDIX A
WILDLIFE SPECIES LIST

**APPENDIX A
COMPILED WILDLIFE SPECIES LIST**

Common Name	Latin Name	SARA* Rank	SARO** Rank	NHIC*** Rank
<u>MAMMALS</u>				
Snowshoe Hare	<i>Lepus americanus</i>	-	-	S5
Eastern Chipmunk	<i>Tamias striatus</i>	-	-	S5
Woodchuck	<i>Marmota monax</i>	-	-	S5
Red Squirrel	<i>Tamiasciurus hudsonicus</i>	-	-	S5
Beaver	<i>Castor canadensis</i>	-	-	S5
Coyote	<i>Canis latrans</i>	-	-	S5
Mink	<i>Mustela vison</i>	-	-	S5
White-tailed Deer	<i>Odocoileus virginianus</i>	-	-	S5
<u>BIRDS</u>				
Canada Goose	<i>Branta canadensis</i>	-	-	S5B
Trumpeter Swan	<i>Cygnus buccinator</i>	NAR	NAR	S4
Wood Duck	<i>Aix sponsa</i>	-	-	S5B
Mallard	<i>Anas platyrhynchos</i>	-	-	S5
Hooded Merganser	<i>Lophodytes cucullatus</i>	-	-	S5B, S5N
Ruffed Grouse	<i>Bonasa umbellus</i>	-	-	S5B
Sharp-tailed Grouse	<i>Tympanuchus phasianellus</i>	-	-	S4B
Common Loon	<i>Gavia immer</i>	NAR	NAR	S5B, S5N
American White Pelican	<i>Pelecanus erythrorhynchos</i>	NAR	THR	S2B
Double-crested Cormorant	<i>Phalacrocorax auritus</i>	NAR	NAR	S5B
American Bittern	<i>Botaurus lentiginosus</i>	-	-	S4B
Great Blue Heron	<i>Ardea herodias</i>	-	-	S4
Green Heron	<i>Butorides virescens</i>	-	-	S4B
Turkey Vulture	<i>Cathartes aura</i>	-	-	S5B
Bald Eagle	<i>Haliaeetus leucocephalus</i>	NAR	SC	S4B
Northern Harrier	<i>Circus cyaneus</i>	NAR	NAR	S4B
Red-tailed Hawk	<i>Buteo jamaicensis</i>	NAR	NAR	S5
Red-shouldered Hawk	<i>Buteo lineatus</i>	NAR	SC	S4B
American Kestrel	<i>Falco sparverius</i>	-	-	S4
Sora	<i>Porzana carolina</i>	-	-	S4B
Sandhill Crane	<i>Grus canadensis</i>	NAR	NAR	S5B
American Golden Plover	<i>Pluvialis dominica</i>	-	-	S2B, S4N
Killdeer	<i>Charadrius vociferus</i>	-	-	S5B, S5N
Wilson's Snipe	<i>Gallinago delicata</i>	-	-	S5B
American Woodcock	<i>Scolopax minor</i>	-	-	S4B
Ring-billed Gull	<i>Larus delawarensis</i>	-	-	S5B
Rock Pigeon	<i>Columba livia</i>	-	-	SNA
Mourning Dove	<i>Zenaida macroura</i>	-	-	S5B
Great Horned Owl	<i>Bubo virginianus</i>	-	-	S5
Barred Owl	<i>Strix varia</i>	-	-	S5
Long-eared Owl	<i>Asio otus</i>	-	-	S4
Northern Saw-whet Owl	<i>Aegolius acadicus</i>	-	-	S4
Common Nighthawk	<i>Chordeiles minor</i>	THR	SC	S4B

Whip-poor-will	<i>Caprimulgus vociferus</i>	THR	THR	S4B
Ruby-throated Hummingbird	<i>Archilochus colubris</i>	-	-	S5B
Belted Kingfisher	<i>Ceryle alcyon</i>	-	-	S4B
Red-headed Woodpecker	<i>Melanerpes erythrocephalus</i>	THR	SC	S4B
Hairy Woodpecker	<i>Picoides villosus</i>	-	-	S5B
Northern Flicker	<i>Colaptes auratus</i>	-	-	S4B
Pileated Woodpecker	<i>Dryocopus pileatus</i>	-	-	S5
Olive-sided Flycatcher	<i>Contopus borealis</i>	THR	SC	S4B
Eastern Wood-Pewee	<i>Contopus virens</i>	-	-	S4B
Yellow-bellied Flycatcher	<i>Empidonax flaviventris</i>	-	-	S5B
Alder Flycatcher	<i>Empidonax alnorum</i>	-	-	S5B
Least Flycatcher	<i>Empidonax minimus</i>	-	-	S4B
Eastern Phoebe	<i>Sayornis phoebe</i>	-	-	S5B
Great Crested Flycatcher	<i>Myiarchus crinitus</i>	-	-	S4B
Eastern Kingbird	<i>Tyrannus tyrannus</i>	-	-	S4B
Blue-headed Vireo	<i>Vireo solitarius</i>	-	-	S5B
Philadelphia Vireo	<i>Vireo philadelphicus</i>	-	-	S5B
Red-eyed Vireo	<i>Vireo olivaceus</i>	-	-	S5B
Gray Jay	<i>Perisoreus canadensis</i>	-	-	S5B
Blue Jay	<i>Cyanocitta cristata</i>	-	-	S5B
Black-billed Magpie	<i>Pica pica</i>	-	-	S3?
American Crow	<i>Corvus brachyrhynchos</i>	-	-	S5B
Common Raven	<i>Corvus corax</i>	-	-	S5B
Tree Swallow	<i>Tachycineta bicolor</i>	-	-	S4B
Northern Rough-winged Swallow	<i>Stelgidopteryx serripennis</i>	-	-	S4B
Cliff Swallow	<i>Petrochelidon pyrrhonota</i>	-	-	S4B
Barn Swallow	<i>Hirundo rustica</i>	-	-	S4B
Black-capped Chickadee	<i>Poecile atricapillus</i>	-	-	S5B
Red-breasted Nuthatch	<i>Sitta canadensis</i>	-	-	S5B
House Wren	<i>Troglodytes aedon</i>	-	-	S5B
Winter Wren	<i>Troglodytes troglodytes</i>	-	-	S5B
Sedge Wren	<i>Cistothorus platensis</i>	NAR	NAR	S4B
Golden-crowned Kinglet	<i>Regulus satrapa</i>	-	-	S5B
Ruby-crowned Kinglet	<i>Regulus calendula</i>	-	-	S5B
Eastern Bluebird	<i>Sialia sialis</i>	NAR	NAR	S5B
Veery	<i>Catharus fuscescens</i>	-	-	S4B
Swainson's Thrush	<i>Catharus ustulatus</i>	-	-	S4B
Hermit Thrush	<i>Catharus guttatus</i>	-	-	S5B
American Robin	<i>Turdus migratorius</i>	-	-	S5B
Gray Catbird	<i>Dumetella carolinensis</i>	-	-	S4B
Brown Thrasher	<i>Toxostoma rufum</i>	-	-	S4B
European Starling	<i>Sturnus vulgaris</i>	-	-	SNA
Cedar Waxwing	<i>Bombycilla cedrorum</i>	-	-	S5B
Golden-winged Warbler	<i>Vermivora chrysoptera</i>	THR	SC	S4B
Tennessee Warbler	<i>Oreothlypis peregrina</i>	-	-	S5B
Nashville Warbler	<i>Oreothlypis ruficapilla</i>	-	-	S5B
Northern Parula	<i>Parula americana</i>	-	-	S4B

Yellow Warbler	<i>Dendroica petechia</i>	-	-	S5B
Chestnut-sided Warbler	<i>Dendroica pensylvanica</i>	-	-	S5B
Magnolia Warbler	<i>Dendroica magnolia</i>	-	-	S5B
Black-throated Blue Warbler	<i>Dendroica caerulescens</i>	-	-	S5B
Yellow-rumped Warbler	<i>Dendroica coronata</i>	-	-	S5B
Black-throated Green Warbler	<i>Dendroica virens</i>	-	-	S5B
Blackburnian Warbler	<i>Dendroica fusca</i>	-	-	S5B
Palm Warbler	<i>Dendroica palmarum</i>	-	-	S5B
Black-and-white Warbler	<i>Mniotilta varia</i>	-	-	S5B
American Redstart	<i>Setophaga ruticilla</i>	-	-	S5B
Ovenbird	<i>Seiurus aurocapilla</i>	-	-	S4B
Mourning Warbler	<i>Oporornis philadelphia</i>	-	-	S4B
Conneticut Warbler	<i>Oporornis agilis</i>	-	-	S4B
Common Yellowthroat	<i>Geothlypis trichas</i>	-	-	S5B
Wilson's Warbler	<i>Wilsonia pusilla</i>	-	-	S4B
Chipping Sparrow	<i>Spizella passerina</i>	-	-	S5B
Clay-colored Sparrow	<i>Spizella pallida</i>	-	-	S4B
Savannah Sparrow	<i>Passerculus sandwichensis</i>	-	-	S4B
LeConte's Sparrow	<i>Ammodramus leconteii</i>	-	-	S4B
Song Sparrow	<i>Melospiza melodia</i>	-	-	S5B
Swamp Sparrow	<i>Melospiza georgiana</i>	-	-	S5B
White-throated Sparrow	<i>Zonotrichia albicollis</i>	-	-	S5B
Rose-breasted Grosbeak	<i>Pheucticus ludovicianus</i>	-	-	S4B
Bobolink	<i>Dolichonyx oryzivorus</i>	THR	THR	S4B
Red-winged Blackbird	<i>Agelaius phoeniceus</i>	-	-	S4
Brewer's Blackbird	<i>Euphagus cyanocephalus</i>	-	-	S4B
Common Grackle	<i>Quiscalus quiscula</i>	-	-	S5B
Brown-headed Cowbird	<i>Molothrus ater</i>	-	-	S4B
Baltimore Oriole	<i>Icterus galbula</i>	-	-	S4B
Pine Siskin	<i>Spinus pinus</i>	-	-	S4B
American Goldfinch	<i>Spinus tristis</i>	-	-	S5B
House Sparrow	<i>Passer domesticus</i>	-	-	SNA
<u>REPTILES</u>				
Western Painted Turtle	<i>Chrysemys picta belli</i>	-	-	S5
<u>AMPHIBIANS</u>				
American Toad	<i>Bufo americanus</i>	-	-	S5
Tetraploid Gray Treefrog	<i>Hyla versicolor</i>	-	-	S5
Spring Peeper	<i>Pseudacris crucifer</i>	-	-	S5
Boreal Chorus Frog	<i>Pseudacris maculata</i>	-	-	S5
Wood Frog	<i>Rana sylvatica</i>	-	-	S5
Northern Leopard Frog	<i>Rana pipiens</i>	NAR	NAR	S5
Mink Frog	<i>Rana septentrionalis</i>	-	-	S5
<u>INVERTEBRATES</u>				
Baskettail Sp.	<i>Epitheca sp.</i>	-	-	S5
Kennedy's Emerald	<i>Somatochlora kennedyii</i>	-	-	S4
Hudsonian Whiteface	<i>Leucorrhinia glacialis</i>	-	-	S5

Four-spotted Skimmer	<i>Libellula quadrimaculata</i>	-	-	S5
Duskywing Sp.	<i>Erynnis sp.</i>	-	-	S5
Canadian Tiger Swallowtail	<i>Papilio canadensis</i>	-	-	S5
Mourning Cloak	<i>Nymphalis antiopa</i>	-	-	S5

* **SARA** = *Species at Risk Act* and is the Federal Status. Rankings are provided by the Committee on the Status of Endangered Wildlife in Canada (COSEWIC).

** **SARO** = *Species at Risk in Ontario* and is the Provincial Status. Rankings are provided by the Committee on the Status of Species at Risk in Ontario (COSSARO).

*****NHIC** = *Natural Heritage Information Centre* and is a database maintained by Ontario's Ministry of Natural Resources.

SARA (Federal Ranking)		SARO (Prov. Ranking)		NHIC (MNR Provincial Ranking)	
NAR	Not At Risk	NAR	Not At Risk	S2B	Imperiled - Breeding Migrants
SC	Special Concern	SC	Special Concern	S3?	Vulnerable - Rank Uncertain
THR	Threatened	THR	Threatened	S4	Apparently Secure
END	Endangered	END	Endangered	S4B	Apparently Secure Breeding Migrants
				S4N	Apparently Secure Non-breeding Migrants
				S5	Secure
				S5B	Secure Breeding Migrants
				S5N	Secure Non-breeding Migrants
				SNA	Status Rank Not Applicable



APPENDIX B

AMPHIBIAN MONITORING DATASHEETS

Amphibian Data Form

Return by 31 July to Aquatic Surveys Officer, Bird Studies Canada, P.O. Box 160, Port Rowan, Ontario, Canada, N0E 1M0

Please write legibly (in pen).

Observer: <u>M/J</u>
Route name:

Date (dd-mm-yr): <u>24/05/11</u>	Visit No.: <u>1</u>	Start time (24 hr clock): <u>21:20</u>
Beaufort Wind Scale No.: <u>0</u>	Cloud Cover (10ths): <u>0</u>	Air Temp (°C or °F): <u>5°C</u>
Precipitation (check one): None/dry: <input checked="" type="checkbox"/> Damp/Haze/Fog: <input type="checkbox"/> Drizzle: <input type="checkbox"/> Rain: <input type="checkbox"/>		
Has the habitat on your route changed from previous years: Yes: <input type="checkbox"/> No: <input checked="" type="checkbox"/> Not applicable: <input type="checkbox"/>		
Remarks: <u>Very cold, overall very low call freq.</u>		

CALL LEVEL CODES
Code 1: Calls not simultaneous, number of individuals can be accurately counted
Code 2: Some calls simultaneous, number of individuals can be reliably estimated
Code 3: Full chorus, calls continuous and overlapping, number of individuals cannot be reliably estimated

Species	In*	Out*
AMTO		
BCFR	1	
BULL		
CHFR		
CGTR		
FOTO		
GRTR		
GRFR		
MIFR		
NLFR		
PIFR		
SPPE	3	
WOFR	1	

* Check if species calling from inside and/or outside 100-metre station area.

Station 1 (OW2)

21:20

S

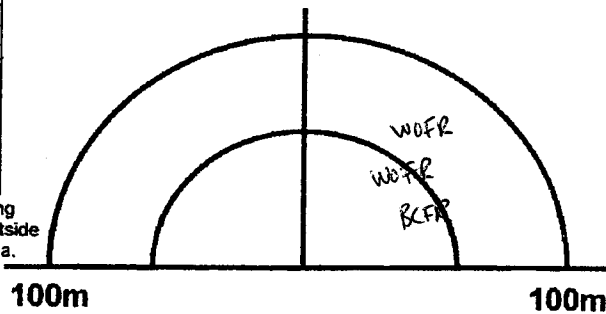

- marsh surrounded by mixed forest

Species	In*	Out*
AMTO		
BCFR		1
BULL		
CHFR		
CGTR		
FOTO		
GRTR		
GRFR		
MIFR		
NLFR		
PIFR		
SPPE		2
WOFR		

* Check if species calling from inside and/or outside 100-metre station area.

Station 2 (OW3)

21:49

N

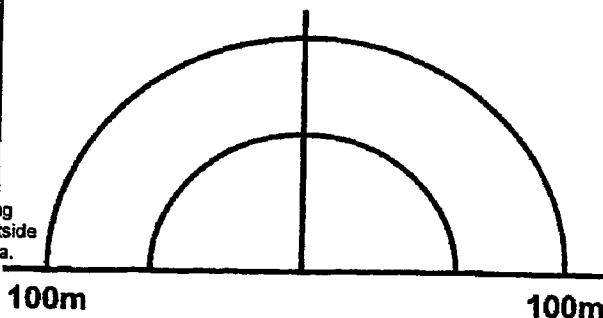

Species	In*	Out*
AMTO		
BCFR		
BULL		
CHFR		
CGTR		
FOTO		
GRTR		
GRFR		
MIFR		
NLFR		
PIFR		
SPPE		1
WOFR		

Station A³ (0W4) (AM5)

20:30

E

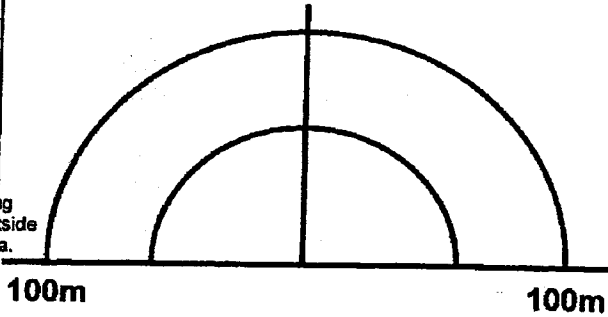

* Check if species calling from inside and/or outside 100-metre station area.

Species	In*	Out*
AMTO		
BCFR		Z
BULL		
CHFR		
CGTR		
FOTO		
GRTR		
GRFR		
MIFR		
NLFR		
PIFR		
SPPE		1
WOFR		

Station 4 (0W5) (AM4)

23:06

S

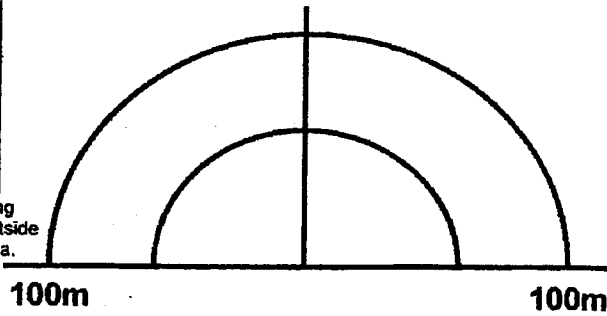

* Check if species calling from inside and/or outside 100-metre station area.

Species	In*	Out*
AMTO		
BCFR		
BULL		
CHFR		
CGTR		
FOTO		
GRTR		
GRFR		
MIFR		
NLFR		
PIFR		
SPPE		Z
WOFR		Z

Station A⁵ (0W6) (AM3)

23:40

N

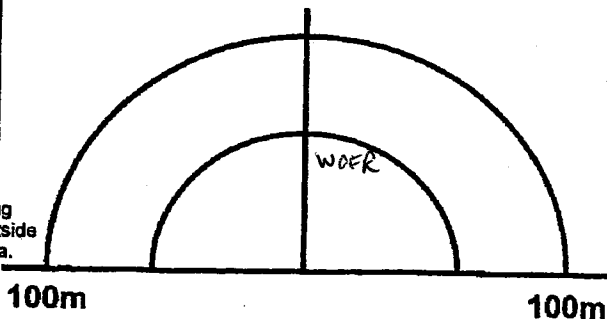

* Check if species calling from inside and/or outside 100-metre station area.

Amphibian Data Form

Return by 31 July to Aquatic Surveys Officer, Bird Studies Canada, P.O. Box 160, Port Rowan, Ontario, Canada, N0E 1M0

Please write legibly (in pen).

Observer: <u>Jon Pleizier + Matt Evans</u>
Route name:

Date (dd-mm-yr): <u>May 25 2011</u>	Visit No.: <u>1</u>	Start time (24 hr clock): <u>21:07</u>
Beaufort Wind Scale No.: <u>1</u>	Cloud Cover (10ths): <u>10</u>	Air Temp (°C or °F): <u>5-7</u>
Precipitation (check one): None/dry: <input checked="" type="checkbox"/> Damp/Haze/Fog: <input type="checkbox"/> Drizzle: <input type="checkbox"/> Rain: <input type="checkbox"/>		
Has the habitat on your route changed from previous years: Yes: <input type="checkbox"/> No: <input type="checkbox"/> Not applicable: <input type="checkbox"/>		
Remarks: <u>Cold, overall low calling freq.</u>		

CALL LEVEL CODES
Code 1: Calls not simultaneous, number of individuals can be accurately counted
Code 2: Some calls simultaneous, number of individuals can be reliably estimated
Code 3: Full chorus, calls continuous and overlapping, number of individuals cannot be reliably estimated

Species	In*	Out*
AMTO		
BCFR		
BULL		
CHFR		
CGTR		
FOTO		
GRTR		
GRFR		
MIFR		
NLFR		
PIFR		
SPPE	1	1
WOFR		

* Check if species calling from inside and/or outside 100-metre station area.

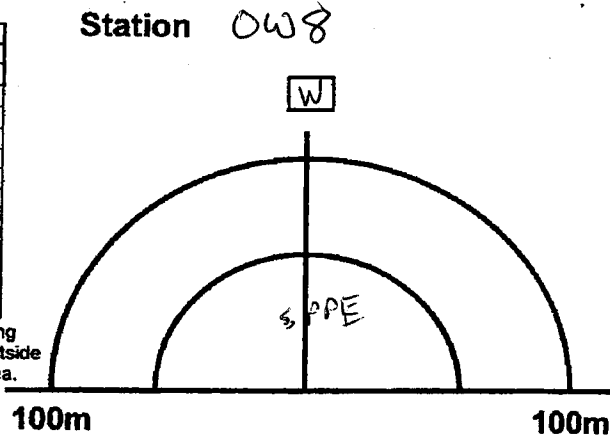

Species	In*	Out*
AMTO		
BCFR		
BULL		
CHFR		
CGTR		
FOTO		
GRTR		
GRFR		
MIFR		
NLFR		
PIFR		
SPPE	1	1
WOFR		

* Check if species calling from inside and/or outside 100-metre station area.

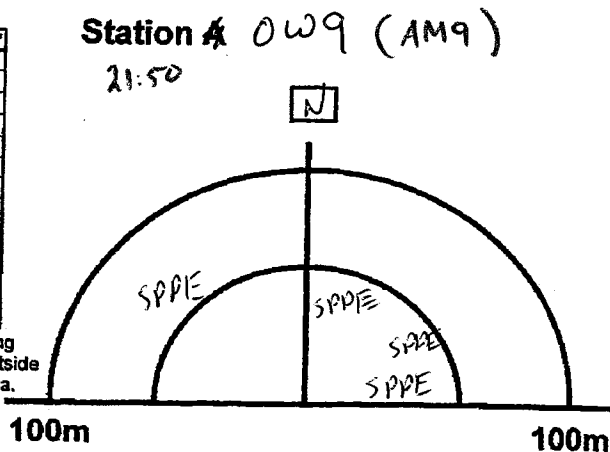

Species	In*	Out*
AMTO		
BCFR		
BULL		
CHFR		
CGTR		
FOTO		
GRTR		
GRFR		
MIFR		
NLFR		
PIFR		
SPPE		
WOFR		

Station AMEC 24

22:21

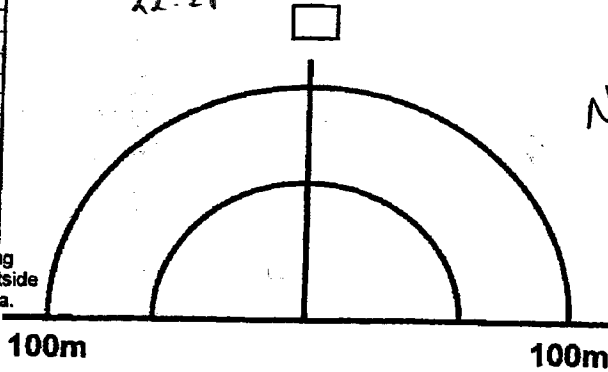

No frogs

* Check if species calling from inside and/or outside 100-metre station area.

Species	In*	Out*
AMTO		
BCFR		
BULL		
CHFR		
CGTR		
FOTO		
GRTR		
GRFR		
MIFR		
NLFR		
PIFR		
SPPE		
WOFR		

Station OW7

22:50

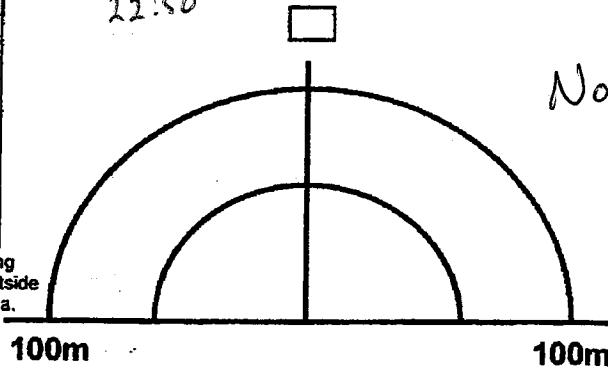

No frogs

* Check if species calling from inside and/or outside 100-metre station area.

Species	In*	Out*
AMTO		
BCFR		
BULL		
CHFR		
CGTR		
FOTO		
GRTR		
GRFR		
MIFR		
NLFR		
PIFR		
SPPE		
WOFR		

Station AMEC 26

23:20

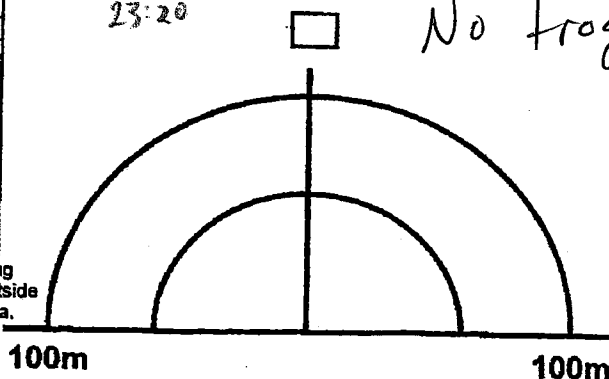

No frogs

* Check if species calling from inside and/or outside 100-metre station area.

Amphibian Data Form

Return by 31 July to Aquatic Surveys Officer, Bird Studies Canada, P.O. Box 160, Port Rowan, Ontario, Canada, NOE 1M0

Please write legibly (in pen).

Observer:	Jon Pleizier + Matt Evans
Route name:	

Date (dd-mm-yr): May 26, 2011	Visit No.: 1	Start time (24 hr clock): 20:56
Beaufort Wind Scale No.: 0	Cloud Cover (10ths):	Air Temp (°C or °F):
Precipitation (check one): None/dry: <input checked="" type="checkbox"/> Damp/Haze/Fog: _____ Drizzle: _____ Rain: _____		
Has the habitat on your route changed from previous years: Yes: _____ No: _____ Not applicable: _____		
Remarks: <i>A</i>		

CALL LEVEL CODES
Code 1: Calls not simultaneous, number of individuals can be accurately counted
Code 2: Some calls simultaneous, number of individuals can be reliably estimated
Code 3: Full chorus, calls continuous and overlapping, number of individuals cannot be reliably estimated

Species	In*	Out*
AMTO		
BCFR		
BULL		
CHFR		
CGTR		
FOTO		
GRTR		
GRFR		
MIFR		
NLFR		
PIFR		
SPPE		
WOFR		

* Check if species calling from inside and/or outside 100-metre station area.

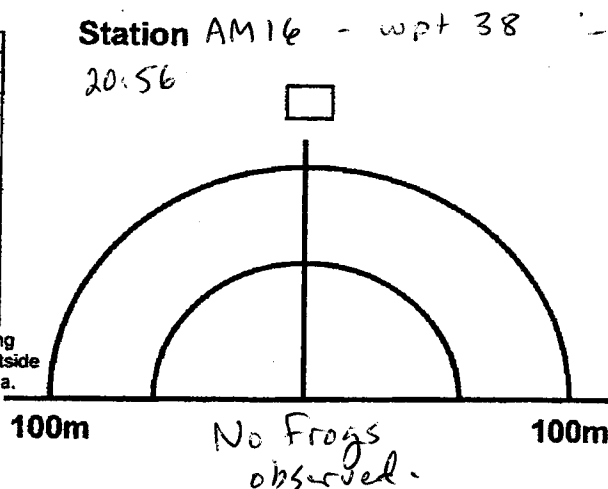

Species	In*	Out*
AMTO		
BCFR		
BULL		
CHFR		
CGTR		
FOTO		
GRTR		
GRFR		
MIFR		
NLFR		
PIFR		
SPPE		
WOFR		

* Check if species calling from inside and/or outside 100-metre station area.

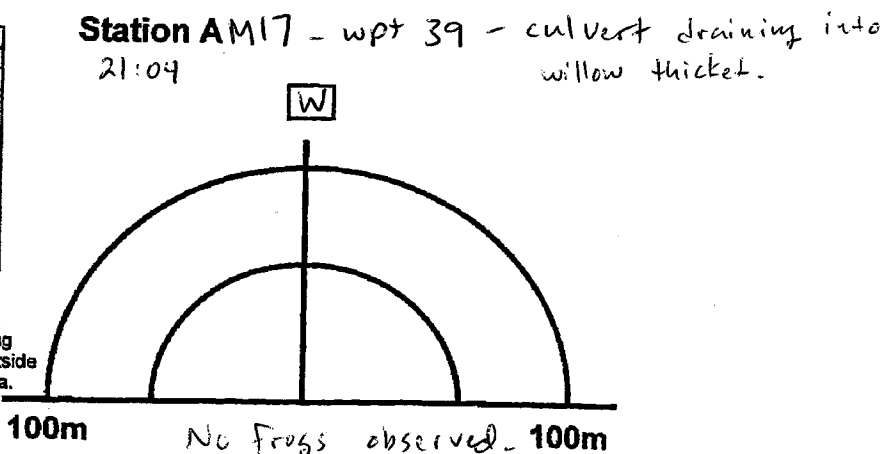

Species	In*	Out*
AMTO		
BCFR		
BULL		
CHFR		
CGTR		
FOTO		
GRTR		
GRFR		
MIFR		
NLFR		
PIFR		
SPPE		
WOFR		

* Check if species calling from inside and/or outside 100-metre station area.

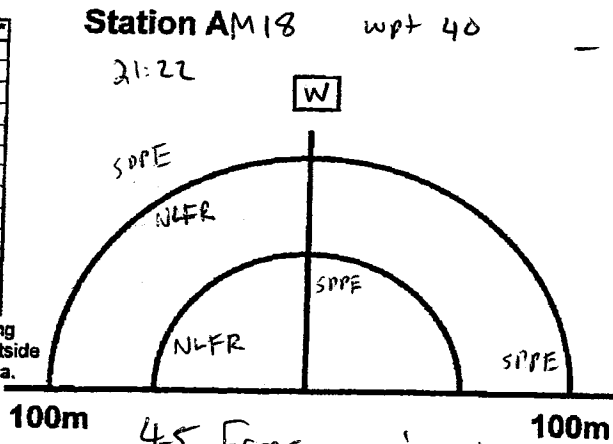

- Beaver pond

45 Frogs seen jumping into pond

Species	In*	Out*
AMTO		
BCFR		
BULL		
CHFR		
CGTR		
FOTO		
GRTR		
GRFR		
MIFR		
NLFR		
PIFR		
SPPE		
WOFR		

* Check if species calling from inside and/or outside 100-metre station area.

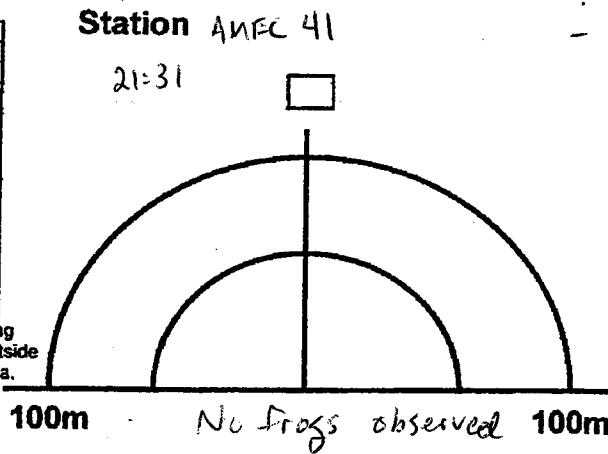

- GBHE, 2 TRUS + trumpet swans

No Frogs observed

Species	In*	Out*
AMTO		
BCFR		
BULL		
CHFR		
CGTR		
FOTO		
GRTR		
GRFR		
MIFR		
NLFR		
PIFR		
SPPE		
WOFR		

* Check if species calling from inside and/or outside 100-metre station area.

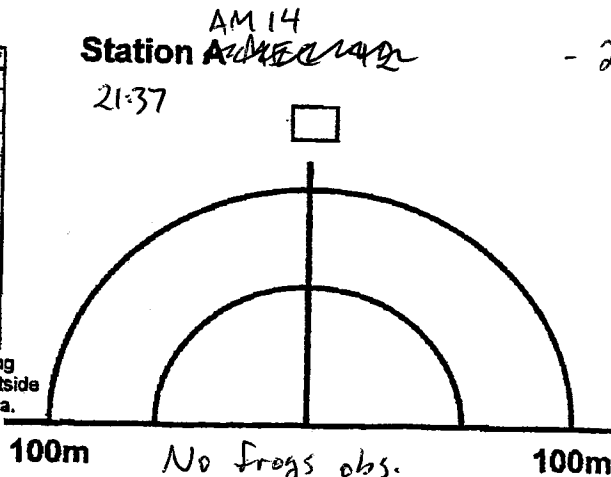

- 2x WODU - Flyover

No Frogs obs.

Amphibian Data Form

Return by 31 July to Aquatic Surveys Officer, Bird Studies Canada, P.O. Box 160, Port Rowan, Ontario, Canada, NOE 1M0

Please write legibly (in pen).

Observer: <i>Jon Pleziers + Matt Evans</i>
Route name:

Date (dd-mm-yr): <i>May 26, 2011</i>	Visit No.: <i>1</i>	Start time (24 hr clock):
Beaufort Wind Scale No.: <i>0-</i>	Cloud Cover (10ths): <i>10 1/2</i>	Air Temp (°C or °F):
Precipitation (check one): None/dry: <input checked="" type="checkbox"/> Damp/Haze/Fog: _____ Drizzle: _____ Rain: _____		
Has the habitat on your route changed from previous years: Yes: _____ No: _____ Not applicable: _____		
Remarks:		

CALL LEVEL CODES
Code 1: Calls not simultaneous, number of individuals can be accurately counted
Code 2: Some calls simultaneous, number of individuals can be reliably estimated
Code 3: Full chorus, calls continuous and overlapping, number of individuals cannot be reliably estimated

Species	In*	Out*
AMTO		
BCFR		
BULL		
CHFR		
CGTR		
FOTO		
GRTR		
GRFR		
MIFR		
NLFR		
PIFR		
SPPE		
WOFR		

* Check if species calling from inside and/or outside 100-metre station area.

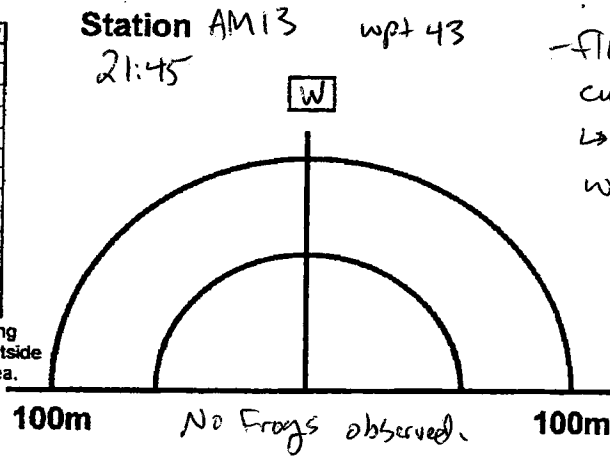

*- flowing stream through culvert, into pasture
↳ very little veg at banks which are eroded.*

Species	In*	Out*
AMTO		
BCFR		
BULL		
CHFR		
CGTR		
FOTO		
GRTR		
GRFR		
MIFR		
NLFR		
PIFR		
SPPE		
WOFR		

* Check if species calling from inside and/or outside 100-metre station area.

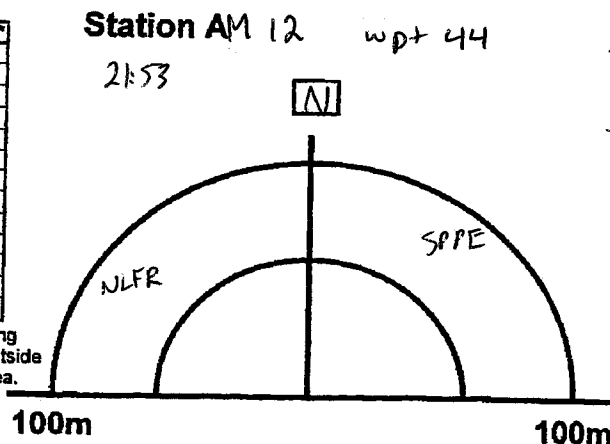

*- wet grassy area
- AMBI x2*

Species	In*	Out*
AMTO		
BCFR		
BULL		
CHFR		
CGTR		
FOTO		
GRTR		
GRFR		
MIFR		
NLFR		
PIFR		
SPPE		
WOFR		

Station AM10 wpt 45

22:05

W

WRW1
AMBI

* Check if species calling from inside and/or outside 100-metre station area.

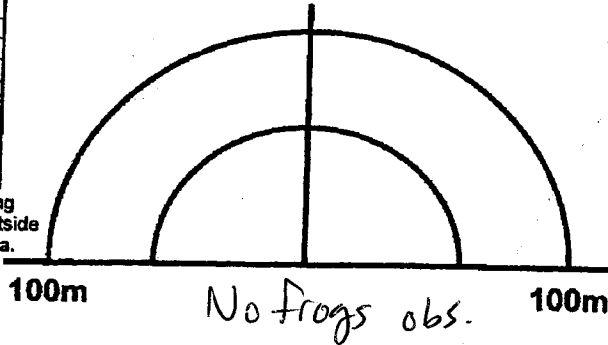

Species	In*	Out*
AMTO		
BCFR		
BULL		
CHFR		
CGTR		
FOTO		
GRTR		
GRFR		
MIFR		
NLFR		
PIFR		
SPPE		
WOFR		

Station AM11 wpt 46

22:13

W

* Check if species calling from inside and/or outside 100-metre station area.

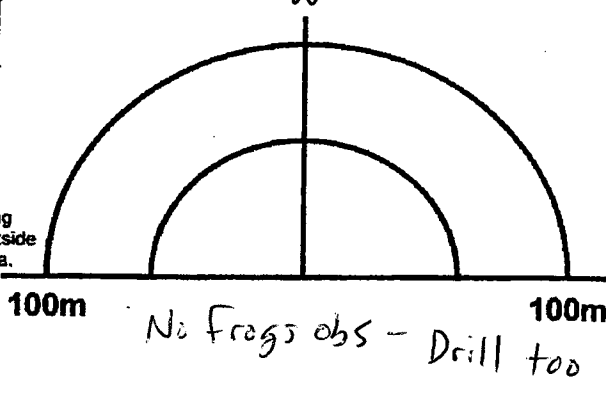

Species	In*	Out*
AMTO		
BCFR		
BULL		
CHFR		
CGTR		
FOTO		
GRTR		
GRFR		
MIFR		
NLFR		
PIFR		
SPPE		
WOFR		

Station AM4 wpt 47

22:19

□

* Check if species calling from inside and/or outside 100-metre station area.

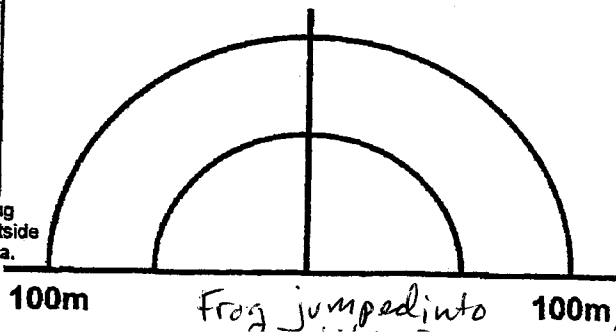

Amphibian Data Form

Return by 31 July to Aquatic Surveys Officer, Bird Studies Canada, P.O. Box 160, Port Rowan, Ontario, Canada, NOE 1M0

Please write legibly (in pen).

Observer: <u>Jon Pleizier + Matt Evans</u>
Route name:

Date (dd-mm-yr): <u>May 26, 2011</u>	Visit No.: <u>1</u>	Start time (24 hr clock):
Beaufort Wind Scale No.:	Cloud Cover (10ths): <u>10%</u>	Air Temp (°C or °F):
Precipitation (check one): None/dry: <input checked="" type="checkbox"/> Damp/Haze/Fog: <input type="checkbox"/> Drizzle: <input type="checkbox"/> Rain: <input type="checkbox"/>		
Has the habitat on your route changed from previous years: Yes: <input type="checkbox"/> No: <input type="checkbox"/> Not applicable: <input type="checkbox"/>		
Remarks:		

CALL LEVEL CODES
Code 1: Calls not simultaneous, number of individuals can be accurately counted
Code 2: Some calls simultaneous, number of individuals can be reliably estimated
Code 3: Full chorus, calls continuous and overlapping, number of individuals cannot be reliably estimated

Species	In*	Out*
AMTO		
BCFR		
BULL		
CHFR		
CGTR		
FOTO		
GRTR		
GRFR		
MIFR		
NLFR		
PIFR		
SPPE		
WOFR		

* Check if species calling from inside and/or outside 100-metre station area.

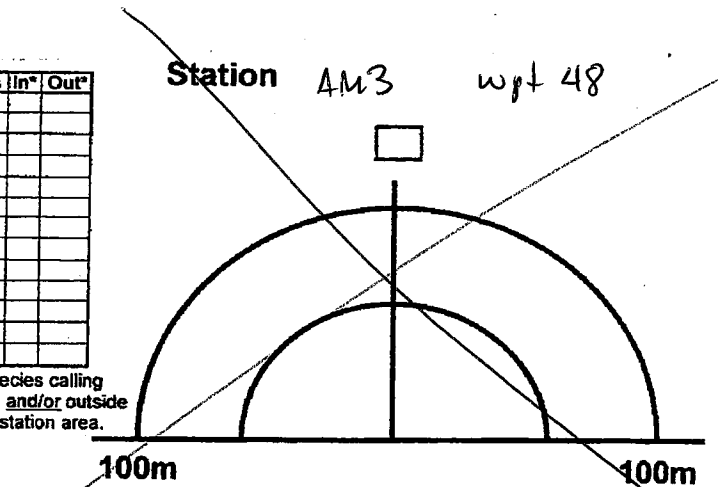

Species	In*	Out*
AMTO		
BCFR		
BULL		
CHFR		
CGTR		
FOTO		
GRTR		
GRFR		
MIFR		
NLFR		
PIFR		
SPPE		
WOFR		

* Check if species calling from inside and/or outside 100-metre station area.

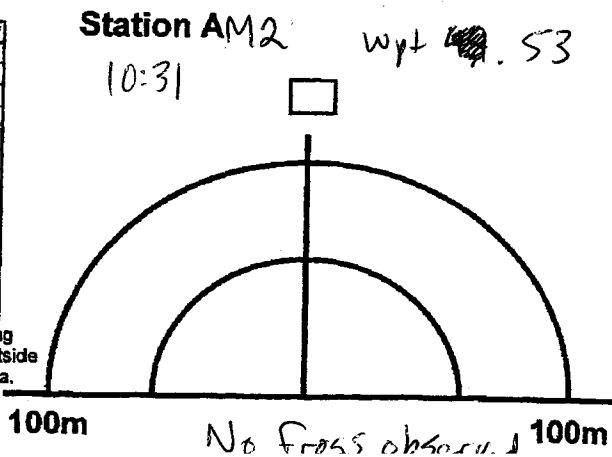

5/5

Species	In*	Out*
AMTO		
BCFR		
BULL		
CHFR		
CGTR		
FOTO		
GRTR		
GRFR		
MIFR		
NLFR		
PIFR		
SPPE		
WOFR		

Station A

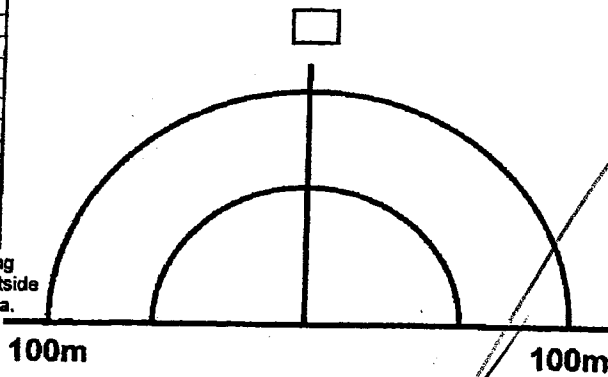

* Check if species calling from inside and/or outside 100-metre station area.

End of Day.

Species	In*	Out*
AMTO		
BCFR		
BULL		
CHFR		
CGTR		
FOTO		
GRTR		
GRFR		
MIFR		
NLFR		
PIFR		
SPPE		
WOFR		

Station

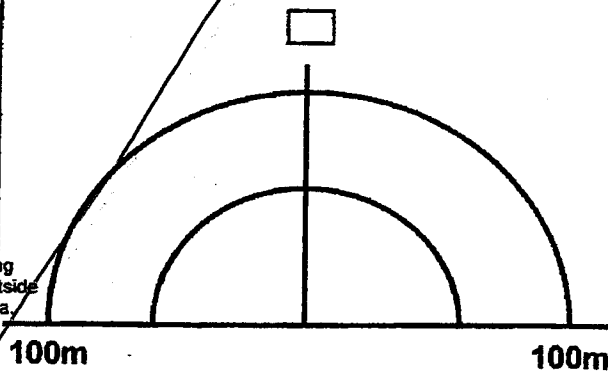

* Check if species calling from inside and/or outside 100-metre station area.

Species	In*	Out*
AMTO		
BCFR		
BULL		
CHFR		
CGTR		
FOTO		
GRTR		
GRFR		
MIFR		
NLFR		
PIFR		
SPPE		
WOFR		

Station A

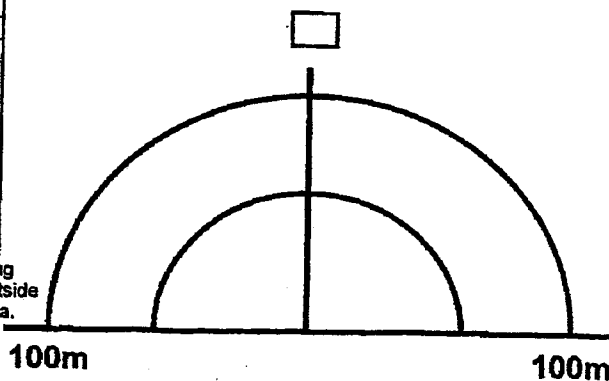

* Check if species calling from inside and/or outside 100-metre station area.

Amphibian Data Form

Return by 31 July to Aquatic Surveys Officer, Bird Studies Canada, P.O. Box 160, Port Rowan, Ontario, Canada, NOE 1M0

Please write legibly (in pen).

Observer:	Jon Pleizier
Route name:	RR

Date (dd-mm-yr): June 14, 2011	Visit No.: 2	Start time (24 hr clock): 22:45
Beaufort Wind Scale No.: 1	Cloud Cover (10ths):	Air Temp (°C or °F): 13°C
Precipitation (check one): None/dry: <input checked="" type="checkbox"/> Damp/Haze/Fog: _____ Drizzle: _____ Rain: _____		
Has the habitat on your route changed from previous years: Yes: _____ No: _____ Not applicable: _____		
Remarks: Full moon, high water levels		

CALL LEVEL CODES
Code 1: Calls not simultaneous, number of individuals can be accurately counted
Code 2: Some calls simultaneous, number of individuals can be reliably estimated
Code 3: Full chorus, calls continuous and overlapping, number of individuals cannot be reliably estimated

Species	In*	Out*
AMTO		
BCFR		
BULL		
CHFR		
CGTR		
FOTO		
GRTR	3	
GRFR		
MIFR		
NLFR		
PIFR		
SPPE		
WOFR		

* Check if species calling from inside and/or outside 100-metre station area.

Station AM13 wpt 43

10:50

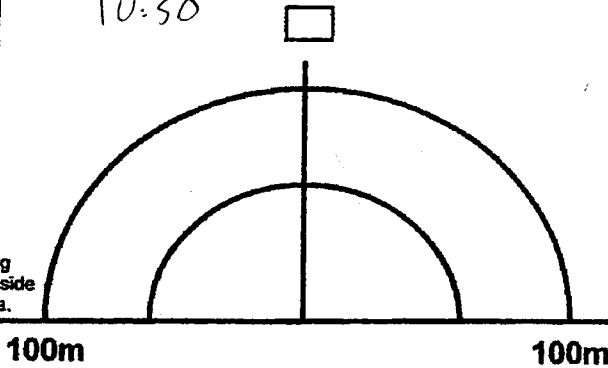

WPW1 calling S of cover

Species	In*	Out*
AMTO		
BCFR		
BULL		
CHFR		
CGTR		
FOTO		
GRTR	1	3
GRFR		
MIFR		
NLFR		
PIFR		
SPPE		
WOFR		

* Check if species calling from inside and/or outside 100-metre station area.

Station A AM12 wpt 44

11:12

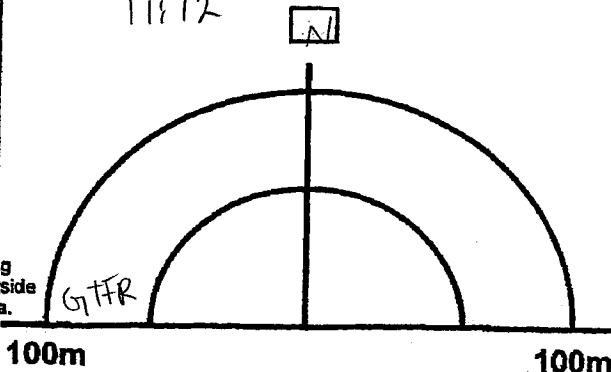

Species	In*	Out*
AMTO		1
BCFR		
BULL		
CHFR		
CGTR		
FOTO		
GRTR	3	
GRFR		
MIFR		
NLFR		
PIFR		
SPPE		
WOFR	2	

Station # OW7 (25)

11:24

S

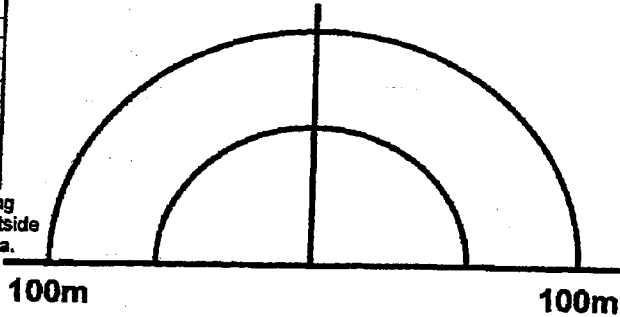

* Check if species calling from inside and/or outside 100-metre station area.

SEWR, KILL

Species	In*	Out*
AMTO		
BCFR		
BULL		
CHFR		
CGTR		
FOTO		
GRTR	3	
GRFR		
MIFR		
NLFR		
PIFR		
SPPE		
WOFR		

Station AM11 wpt 46

11:30

W

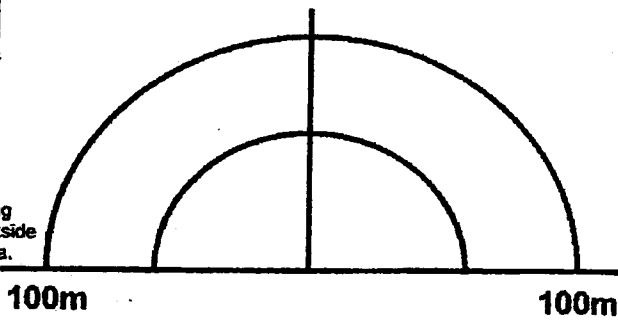

* Check if species calling from inside and/or outside 100-metre station area.

Species	In*	Out*
AMTO	2	
BCFR		
BULL		
CHFR		
CGTR		
FOTO		
GRTR	2	
GRFR		
MIFR		
NLFR		
PIFR		
SPPE		
WOFR		

Station AM 4 (47)

11:37

S

SEWR x 2

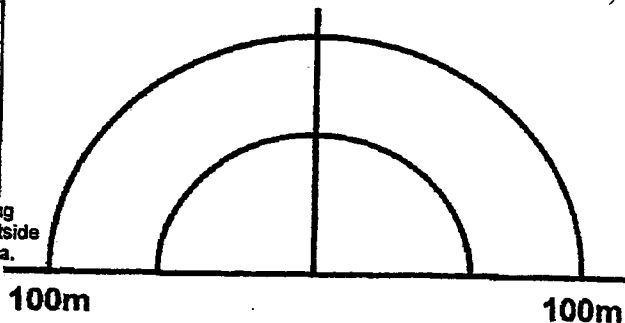

* Check if species calling from inside and/or outside 100-metre station area.

Amphibian Data Form

Return by 31 July to Aquatic Surveys Officer, Bird Studies Canada, P.O. Box 160, Port Rowan, Ontario, Canada, NOE 1M0

Please write legibly (in pen).

Observer:	Jon Plezic
Route name:	RR

Date (dd-mm-yr): June 14, 2011	Visit No.: 2	Start time (24 hr clock): 22:45
Beaufort Wind Scale No.: 1	Cloud Cover (10ths):	Air Temp (°C or °F): 13°C
Precipitation (check one): None/dry: <input checked="" type="checkbox"/> Damp/Haze/Fog: <input type="checkbox"/> Drizzle: <input type="checkbox"/> Rain: <input type="checkbox"/>		
Has the habitat on your route changed from previous years: Yes: <input type="checkbox"/> No: <input type="checkbox"/> Not applicable: <input type="checkbox"/>		
Remarks: Full moon		

CALL LEVEL CODES
Code 1: Calls not simultaneous, number of individuals can be accurately counted
Code 2: Some calls simultaneous, number of individuals can be reliably estimated
Code 3: Full chorus, calls continuous and overlapping, number of individuals cannot be reliably estimated

Species	In*	Out*
AMTO	3	
BCFR	1	
BULL		
CHFR		
CGTR		
FOTO		
GRTR	3	
GRFR		
MIFR		
NLFR		
PIFR		
SPPE		
WOFR		

* Check if species calling from inside and/or outside 100-metre station area.

Station AM3 (59)

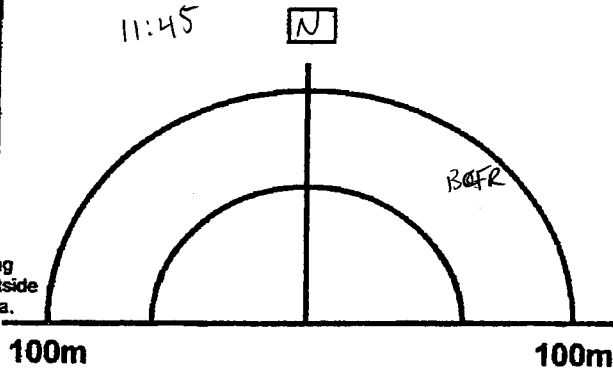

Species	In*	Out*
AMTO	3	
BCFR		
BULL		
CHFR		
CGTR		
FOTO		
GRTR	1	
GRFR		
MIFR		
NLFR		
PIFR		
SPPE		
WOFR		

* Check if species calling from inside and/or outside 100-metre station area.

Station AM2 (48)

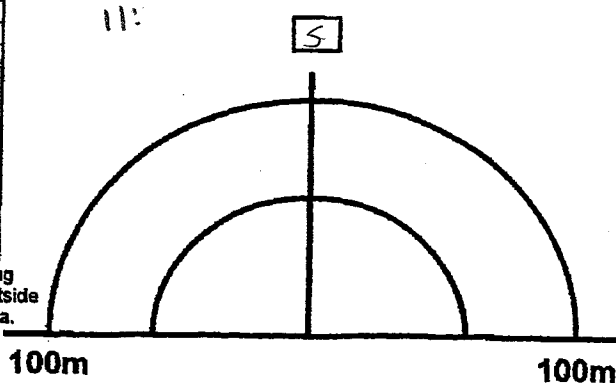

Species	In*	Out*
AMTO		
BCFR		
BULL		
CHFR		
CGTR		
FOTO		
GRTR		
GRFR		
MIFR		
NLFR		
PIFR		
SPPE		
WOFR		

Station A

* Check if species calling from inside and/or outside 100-metre station area.

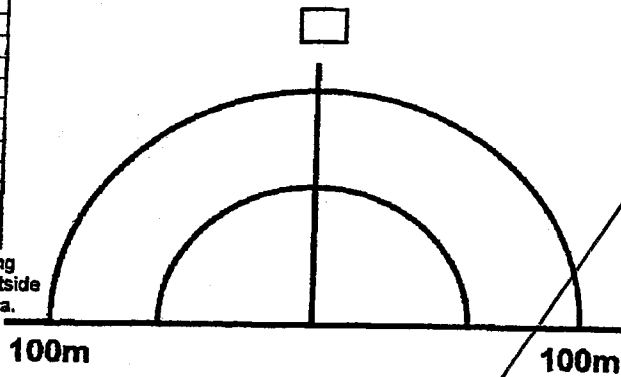

End of Day.

Species	In*	Out*
AMTO		
BCFR		
BULL		
CHFR		
CGTR		
FOTO		
GRTR		
GRFR		
MIFR		
NLFR		
PIFR		
SPPE		
WOFR		

Station

* Check if species calling from inside and/or outside 100-metre station area.

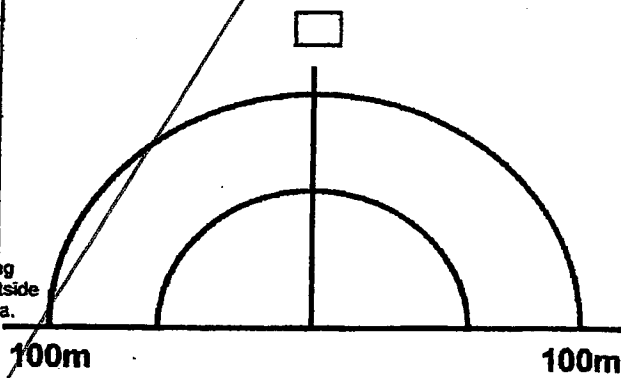

Species	In*	Out*
AMTO		
BCFR		
BULL		
CHFR		
CGTR		
FOTO		
GRTR		
GRFR		
MIFR		
NLFR		
PIFR		
SPPE		
WOFR		

Station A

* Check if species calling from inside and/or outside 100-metre station area.

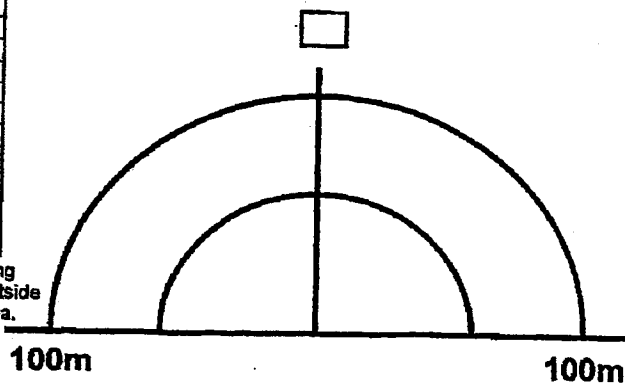

Amphibian Data Form

Return by 31 July to Aquatic Surveys Officer, Bird Studies Canada, P.O. Box 160, Port Rowan, Ontario, Canada, NOE 1M0

Please write legibly (in pen).

Observer:	Jon Pleizier + Matt Evans
Route name:	RR

Date (dd-mm-yr): Jun 15, 2011	Visit No.: 2	Start time (24 hr clock): 21:45
Beaufort Wind Scale No.: 1-2	Cloud Cover (10ths): 8	Air Temp (°C or °F): 12-13°C
Precipitation (check one): None/dry: <input checked="" type="checkbox"/> Damp/Haze/Fog: <input type="checkbox"/> Drizzle: <input type="checkbox"/> Rain: <input type="checkbox"/>		
Has the habitat on your route changed from previous years: Yes: <input type="checkbox"/> No: <input checked="" type="checkbox"/> Not applicable: <input type="checkbox"/>		
Remarks:		

CALL LEVEL CODES
Code 1: Calls not simultaneous, number of individuals can be accurately counted
Code 2: Some calls simultaneous, number of individuals can be reliably estimated
Code 3: Full chorus, calls continuous and overlapping, number of individuals cannot be reliably estimated

Species	In*	Out*
AMTO		
BCFR		
BULL		
CHFR		
CGTR		
FOTO		
GRTR	2	
GRFR		
MIFR		
NLFR		
PIFR		
SPPE		
WOFR		

* Check if species calling from inside and/or outside 100-metre station area.

Station AM18 wpt 40
21:52

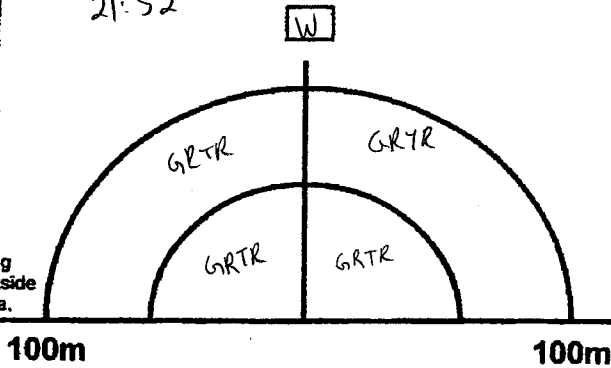

Species	In*	Out*
AMTO		
BCFR		
BULL		
CHFR		
CGTR		
FOTO		
GRTR	1	
GRFR		
MIFR		
NLFR		
PIFR		
SPPE		
WOFR		

* Check if species calling from inside and/or outside 100-metre station area.

Station AM17 wpt 39
22:02

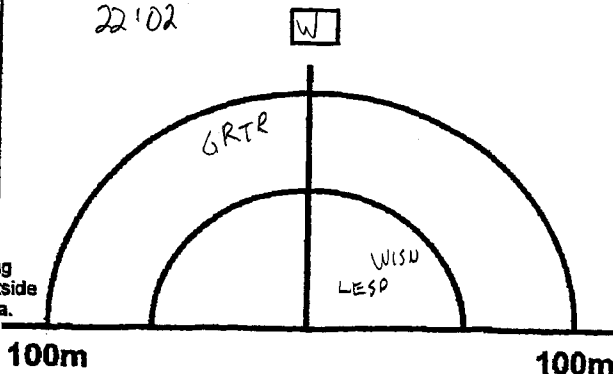

Species	In*	Out*
AMTO		
BCFR		
BULL		
CHFR		
CGTR		
FOTO		
GRTR	3	
GRFR		
MIFR		
NLFR		
PIFR		
SPPE		
WOFR		

Station AM16 (38)

20:09

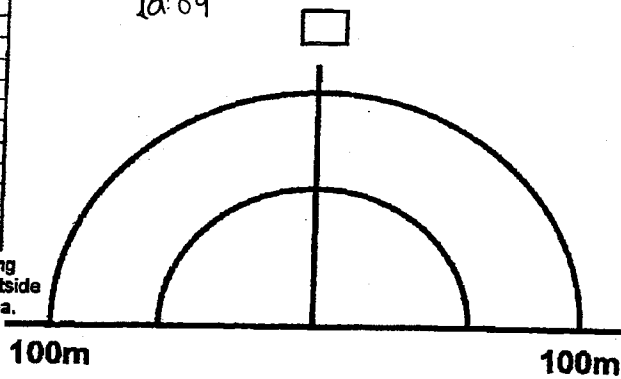

* Check if species calling from inside and/or outside 100-metre station area.

Species	In*	Out*
AMTO		
BCFR		
BULL		
CHFR		
CGTR		
FOTO		
GRTR	3	
GRFR		
MIFR		
NLFR		
PIFR		
SPPE		
WOFR		

Station AMECH1

10:19

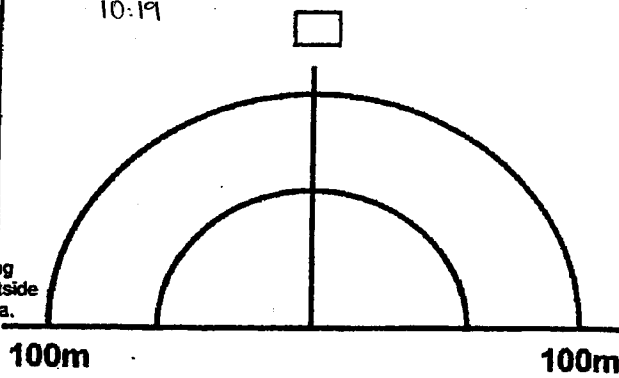

* Check if species calling from inside and/or outside 100-metre station area.

Species	In*	Out*
AMTO	2	
BCFR		
BULL		
CHFR		
CGTR		
FOTO		
GRTR	3	
GRFR		
MIFR		
NLFR		
PIFR		
SPPE		
WOFR		

Station A (42)

10:25

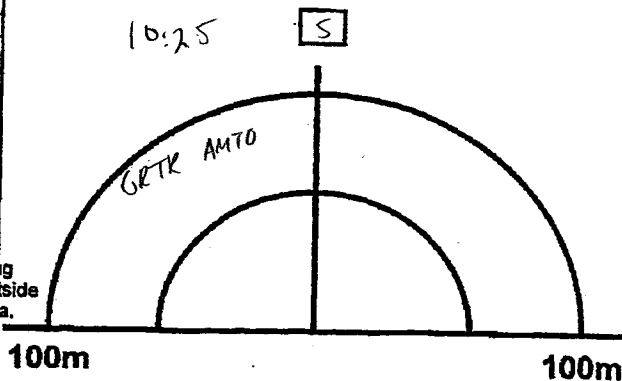

* Check if species calling from inside and/or outside 100-metre station area.

Amphibian Data Form

Return by 31 July to Aquatic Surveys Officer, Bird Studies Canada, P.O. Box 160, Port Rowan, Ontario, Canada, N0E 1M0

Please write legibly (in pen).

Observer:	Jon Pleziers + Matt Evans.
Route name:	RR

Date (dd-mm-yr): June 15, 2011	Visit No.: 2	Start time (24 hr clock): 21:45
Beaufort Wind Scale No.: 1-2	Cloud Cover (10ths): 8	Air Temp (°C or °F): 12-13°C
Precipitation (check one): None/dry: <input checked="" type="checkbox"/> Damp/Haze/Fog: _____ Drizzle: _____ Rain: _____		
Has the habitat on your route changed from previous years: Yes: _____ No: <input checked="" type="checkbox"/> Not applicable: _____		
Remarks:		

CALL LEVEL CODES
Code 1: Calls not simultaneous, number of individuals can be accurately counted
Code 2: Some calls simultaneous, number of individuals can be reliably estimated
Code 3: Full chorus, calls continuous and overlapping, number of individuals cannot be reliably estimated

Species	In*	Out*
AMTO	1	
BCFR		
BULL		
CHFR		
CGTR		
FOTO		
GRTR		3
GRFR		
MIFR		
NLFR		
PIFR		
SPPE		
WOFR	1	

* Check if species calling from inside and/or outside 100-metre station area.

Station AM10

10:47

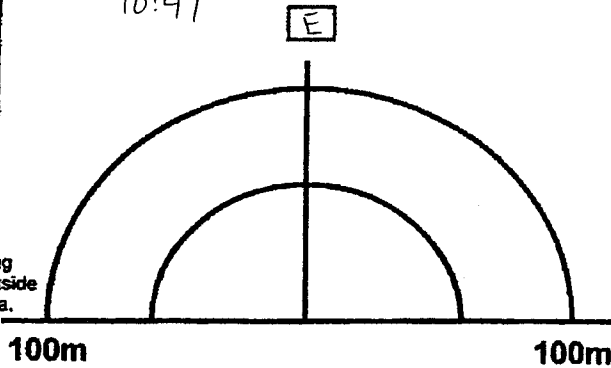

Station AM9

10:59

Species	In*	Out*
AMTO		
BCFR		
BULL		
CHFR		
CGTR		
FOTO		
GRTR		
GRFR		2
MIFR		
NLFR		
PIFR		
SPPE		
WOFR		

* Check if species calling from inside and/or outside 100-metre station area.

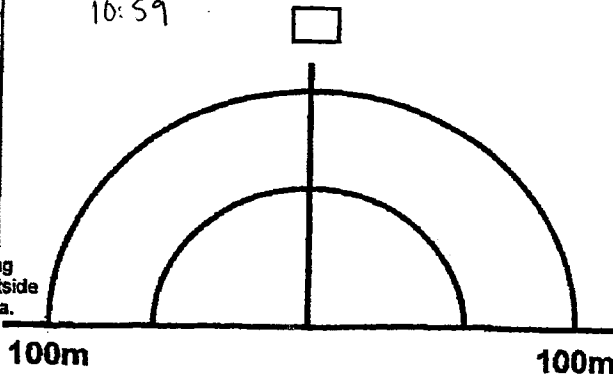

Species	In*	Out*
AMTO		
BCFR		
BULL		
CHFR		
CGTR		
FOTO		
GRTR		
GRFR		
MIFR		
NLFR		
PIFR		
SPPE		
WOFR		

Station A

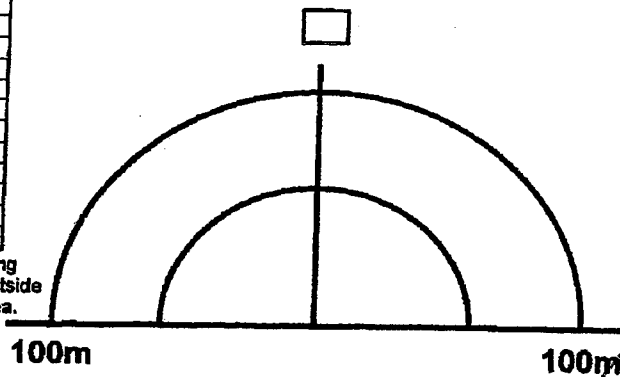

* Check if species calling from inside and/or outside 100-metre station area.

End of Day

Species	In*	Out*
AMTO		
BCFR		
BULL		
CHFR		
CGTR		
FOTO		
GRTR		
GRFR		
MIFR		
NLFR		
PIFR		
SPPE		
WOFR		

Station

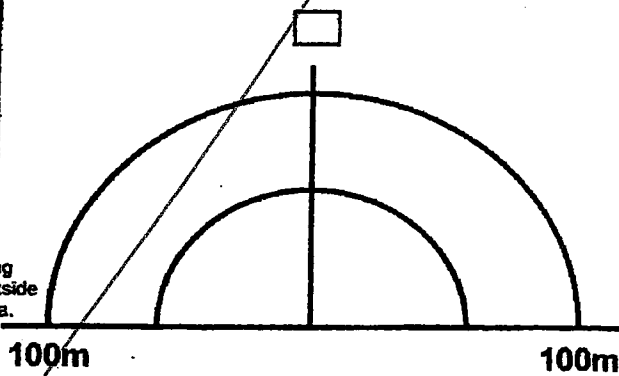

* Check if species calling from inside and/or outside 100-metre station area.

Species	In*	Out*
AMTO		
BCFR		
BULL		
CHFR		
CGTR		
FOTO		
GRTR		
GRFR		
MIFR		
NLFR		
PIFR		
SPPE		
WOFR		

Station A

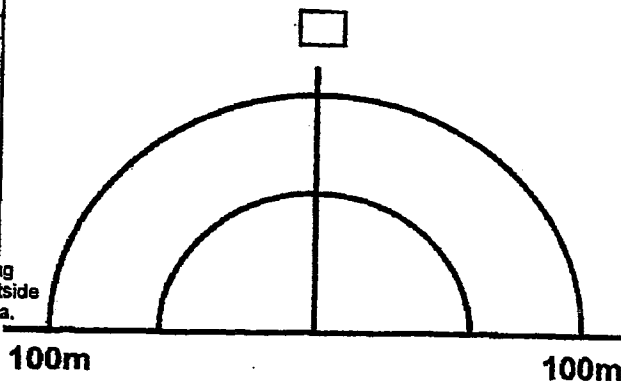

* Check if species calling from inside and/or outside 100-metre station area.

Amphibian Data Form

Return by 31 July to Aquatic Surveys Officer, Bird Studies Canada, P.O. Box 160, Port Rowan, Ontario, Canada, N0E 1M0

Please write legibly (in pen).

Observer:	Jon Pleziers + Matt Evans
Route name:	PK

Date (dd-mm-yr): July 16	Visit No.: 2	Start time (24 hr clock): 12:00
Beaufort Wind Scale No.: 1	Cloud Cover (10ths): 0	Air Temp (°C or °F): 14°C
Precipitation (check one): None/dry: _____ Damp/Haze/Fog: _____ Drizzle: _____ Rain: _____		
Has the habitat on your route changed from previous years: Yes: _____ No: _____ Not applicable: _____		
Remarks:		

CALL LEVEL CODES
Code 1: Calls not simultaneous, number of individuals can be accurately counted
Code 2: Some calls simultaneous, number of individuals can be reliably estimated
Code 3: Full chorus, calls continuous and overlapping, number of individuals cannot be reliably estimated

Species	In*	Out*
AMTO		
BCFR		
BULL		
CHFR		
CGTR		
FOTO		
GRTR	3	
GRFR		
MIFR		
NLFR	1	
PIFR		
SPPE		
WOFR		

* Check if species calling from inside and/or outside 100-metre station area.

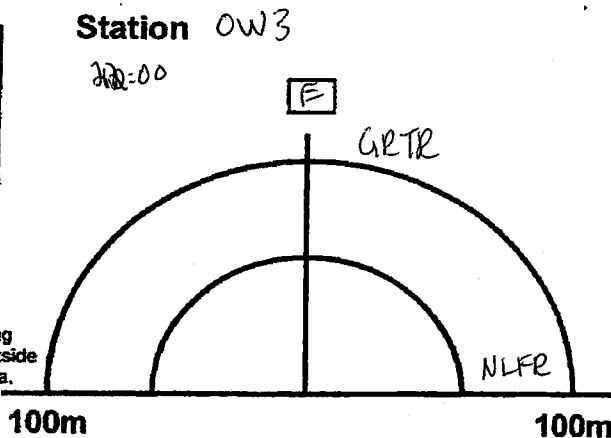

Species	In*	Out*
AMTO		
BCFR		
BULL		
CHFR		
CGTR		
FOTO		
GRTR	3	
GRFR		
MIFR		
NLFR		
PIFR		
SPPE		
WOFR		

* Check if species calling from inside and/or outside 100-metre station area.

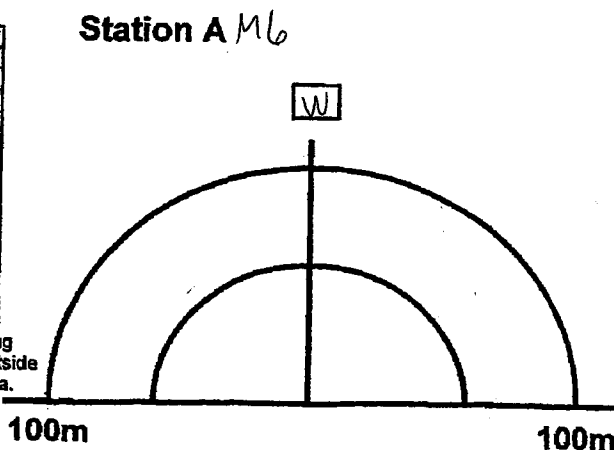

Species	In*	Out*
AMTO		
BCFR		
BULL		
CHFR		
CGTR		
FOTO		
GRTR		3
GRFR		
MIFR		
NLFR		
PIFR		
SPPE		
WOFR		

Station AM5

22:37

E

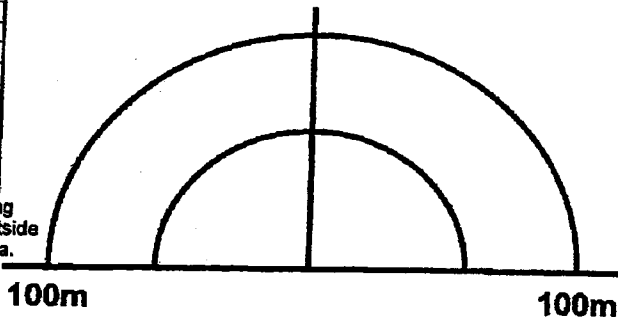

* Check if species calling from inside and/or outside 100-metre station area.

Species	In*	Out*
AMTO	1	
BCFR		
BULL		
CHFR		
CGTR		
FOTO		
GRTR	3	
GRFR		
MIFR		
NLFR		
PIFR		
SPPE		
WOFR		

Station AM4

10:54

S

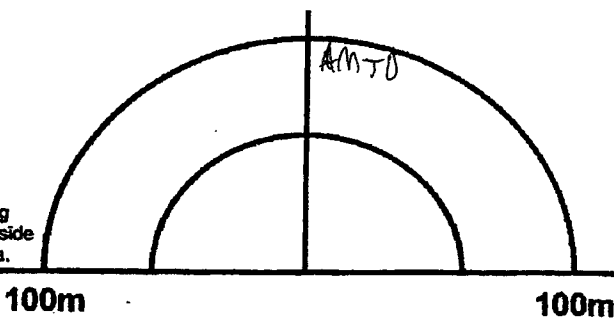

* Check if species calling from inside and/or outside 100-metre station area.

Species	In*	Out*
AMTO	3	
BCFR		
BULL		
CHFR		
CGTR		
FOTO		
GRTR		
GRFR	3	
MIFR		
NLFR		
PIFR		
SPPE		
WOFR		

Station AM3

11:09

N

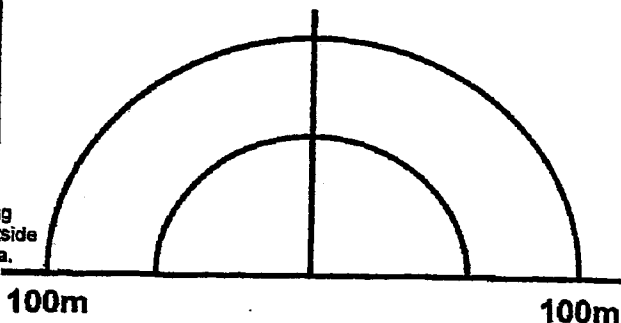

* Check if species calling from inside and/or outside 100-metre station area.

Station ow6

11:30

AMTO In Out
3
GRTR 3
MIFR 3